

# Service Manual

SA8004 /K1SG/U1B  
SA-KI-PEARL-LITE /N1SG/N1B

Super Audio CD player

SA8004  
SA-KI-PEARL-LITE

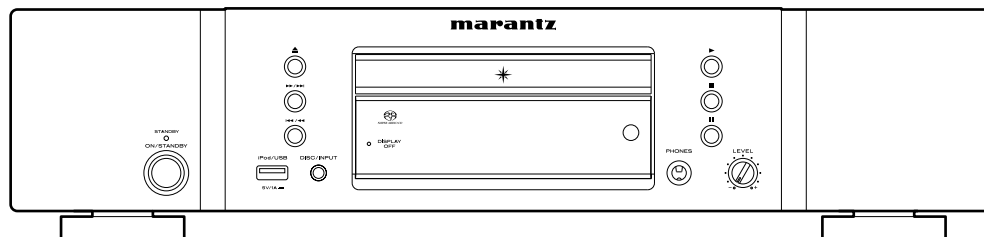

• For purposes of improvement, specifications and design are subject to change without notice.

• Please use this service manual with referring to the operating instructions without fail.

• Some illustrations using in this service manual are slightly different from the actual set.

# marantz®

SA8004  
SA-KI-PEARL-LITE

Ver. 2

Please refer to the  
MODIFICATION NOTICE.

## MARANTZ DESIGN AND SERVICE

Using superior design and selected high grade components, **MARANTZ** company has created the ultimate in stereo sound. Only original **MARANTZ** parts can insure that your **MARANTZ** product will continue to perform to the specifications for which it is famous.

Parts for your **MARANTZ** equipment are generally available to our National Marantz Subsidiary or Agent.

### ORDERING PARTS :

Parts can be ordered either by mail or by Fax.. In both cases, the correct part number has to be specified.

The following information must be supplied to eliminate delays in processing your order :

1. Complete address
2. Complete part numbers and quantities required
3. Description of parts
4. Model number for which part is required
5. Way of shipment
6. Signature : any order form or Fax. must be signed, otherwise such part order will be considered as null and void.

#### USA

**MARANTZ AMERICA, INC**  
100 CORPORATE DRIVE  
MAHWAH, NEW JERSEY 07430  
USA

#### EUROPE / TRADING

**D&M EUROPE B. V.**  
P. O. BOX 8744, BUILDING SILVERPOINT  
BEEEMDSTRAAT 11, 5653 MA EINDHOVEN  
THE NETHERLANDS  
PHONE : +31 - 40 - 2507844  
FAX : +31 - 40 - 2507860

#### CANADA

**D&M Canada Inc.**  
5-505 APPLE CREEK BLVD.  
MARKHAM, ONTARIO L3R 5B1  
CANADA  
PHONE : 905 - 415 - 9292  
FAX : 905 - 475 - 4159

#### JAPAN

**D&M Holdings Inc.**  
D&M BUILDING, 2-1 NISSHIN-CHO,  
KAWASAKI-KU, KAWASAKI-SHI,  
KANAGAWA, 210-8569 JAPAN

株式会社 ディーアンドエムホールディングス  
本社 〒210-8569  
神奈川県川崎市川崎区日進町2-1 D&Mビル

#### KOREA

**D&M SALES AND MARKETING KOREA LTD.**  
2F, YEON BLDG.,  
88-5, BANPO-DONG, SEOCHO-GU,  
SEOUL KOREA  
PHONE : +82 - 2 - 715 - 9041  
FAX : +82 - 2 - 715 - 9040

#### CHINA

**D&M SALES AND MARKETING SHANGHAI LTD.**  
ROOM.808 SHANGHAI AIRPORT CITY TERMINAL  
NO.1600 NANJING (WEST) ROAD, SHANGHAI,  
CHINA. 200040  
TEL : 021 - 6248 - 5151  
FAX : 021 - 6248 - 4434

### NOTE ON SAFETY :

Symbol  $\triangle$  Fire or electrical shock hazard. Only original parts should be used to replaced any part marked with symbol  $\triangle$ .

Any other component substitution (other than original type), may increase risk of fire or electrical shock hazard.

### 安全上の注意 :

$\triangle$ がついている部品は、安全上重要な部品です。必ず指定されている部品番号の部品を使用して下さい。

### SHOCK, FIRE HAZARD SERVICE TEST :

**CAUTION** : After servicing this appliance and prior to returning to customer, measure the resistance between either primary AC cord connector pins (with unit NOT connected to AC mains and its Power switch ON), and the face or Front Panel of product and controls and chassis bottom.

Any resistance measurement less than 1 Megohms should cause unit to be repaired or corrected before AC power is applied, and verified before it is return to the user/customer.

Ref. UL Standard No. 60065.

In case of difficulties, do not hesitate to contact the Technical Department at above mentioned address.

091105DM/DG

## SAFETY PRECAUTIONS

The following check should be performed for the continued protection of the customer and service technician.

### LEAKAGE CURRENT CHECK

Before returning the unit to the customer, make sure you make either (1) a leakage current check or (2) a line to chassis resistance check. If the leakage current exceeds 0.5 milliamps, or if the resistance from chassis to either side of the power cord is less than 460 kohms, the unit is defective.

Be sure to test for leakage current with the AC plug in both polarities, in addition, in each power ON, OFF and STANDBY mode, if applicable.

**CAUTION** Please heed the points listed below during servicing and inspection.

◎ **Heed the cautions!**

Spots requiring particular attention when servicing, such as the cabinet, parts, chassis, etc., have cautions indicated on labels. Be sure to heed these cautions and the cautions indicated in the handling instructions.

◎ **Caution concerning electric shock!**

(1) An AC voltage is impressed on this set, so touching internal metal parts when the set is energized could cause electric shock. Take care to avoid electric shock, by for example using an isolating transformer and gloves when servicing while the set is energized, unplugging the power cord when replacing parts, etc.

(2) There are high voltage parts inside. Handle with extra care when the set is energized.

◎ **Caution concerning disassembly and assembly!**

Through great care is taken when manufacturing parts from sheet metal, there may in some rare cases be burrs on the edges of parts which could cause injury if fingers are moved across them. Use gloves to protect your hands.

◎ **Only use designated parts!**

The set's parts have specific safety properties (fire resistance, voltage resistance, etc.). For replacement parts, be sure to use parts which have the same properties. In particular, for the important safety parts that are marked  $\triangle$  on wiring diagrams and parts lists, be sure to use the designated parts.

◎ **Be sure to mount parts and arrange the wires as they were originally!**

For safety reasons, some parts use tape, tubes or other insulating materials, and some parts are mounted away from the surface of printed circuit boards. Care is also taken with the positions of the wires and clamps are used to keep wires away from heating and high voltage parts, so be sure to set everything back as it was originally.

◎ **Inspect for safety after servicing!**

Check that all screws, parts and wires removed or disconnected for servicing have been put back in their original positions, inspect that no parts around the area that has been serviced have been negatively affected, conduct an insulation check on the external metal connectors and between the blades of the power plug, and otherwise check that safety is ensured.

(Insulation check procedure)

Unplug the power cord from the power outlet, disconnect the antenna, plugs, etc., and turn the power switch on. Using a 500V insulation resistance tester, check that the inplug and the externally exposed metal parts (antenna terminal, headphones terminal, input terminal, etc.) is 1M $\Omega$  or greater. If it is less, the set must be inspected and repaired.

**CAUTION** **Concerning important safety parts**

Many of the electric and structural parts used in the set have special safety properties. In most cases these properties are difficult to distinguish by sight, and using replacement parts with higher ratings (rated power and withstand voltage) does not necessarily guarantee that safety performance will be preserved. Parts with safety properties are indicated as shown below on the wiring diagrams and parts lists in this service manual. Be sure to replace them with parts with the designated part number.

(1) Schematic diagrams ..... Indicated by the  $\triangle$  mark.

(2) Parts lists ..... Indicated by the  $\triangle$  mark.

Using parts other than the designated parts could result in electric shock, fires or other dangerous situations.

# NOTE FOR SCHEMATIC DIAGRAM

**WARNING:**

Parts marked with this symbol  $\triangle$  have critical characteristics. Use ONLY replacement parts recommended by the manufacturer.

**CAUTION:**

Before returning the unit to the customer, make sure you make either (1) a leakage current check or (2) a line to chassis resistance check. If the leakage current exceeds 0.5 milliamps, or if the resistance from chassis to either side of the power cord is less than 460 kohms, the unit is defective.

**WARNING:**

DO NOT return the unit to the customer until the problem is located and corrected.

**NOTICE:**

ALL RESISTANCE VALUES IN OHM. k=1,000 OHM / M=1,000,000 OHM

ALL CAPACITANCE VALUES IN MICRO FARAD. P=MICRO-MICRO FARAD EACH VOLTAGE AND CURRENT ARE MEASURED AT NO SIGNAL INPUT CONDITION. CIRCUIT AND PARTS ARE SUBJECT TO CHANGE WITHOUT PRIOR NOTICE.

# NOTE FOR PARTS LIST

1. Parts for which "nsp" is indicated on this table cannot be supplied.
  2. When ordering of part, clearly indicate "1" and "1" (i) to avoid mis-supplying.
  3. Ordering part without stating its part number can not be supplied.
  4. Part indicated with the mark "★" is not illustrated in the exploded view.
  5. Not including General-purpose Carbon Film Resistor in the P.W.Board parts list. (Refer to the Schematic Diagram for those parts.)
  6. Not including General-purpose Carbon Chip Resistor in the P.W.Board parts list. (Refer to the Schematic Diagram for those parts.)
- WARNING:** Parts marked with this symbol  $\triangle$  have critical characteristics. Use ONLY replacement parts recommended by the manufacturer.

● **Resistors**

Ex.:      RN      14K      2E      182      G      FR

Type      Shape and performance      Power      Resistance      Allowable error      Others

RD : Carbon	2B : 1/8 W	F : ±1%	P : Pulse-resistant type
RC : Composition	2E : 1/4 W	G : ±2%	NL : Low noise type
RS : Metal oxide film	2H : 1/2 W	J : ±5%	NB : Non-burning type
RW: winding	3A : 1 W	K : ±10%	FR : Fuse-resistor
RN: Metal film	3D : 2 W	M : ±20%	F : Lead wire forming
RK : Metal mixture	3F : 3 W		
	3H : 5 W		

\* Resistance

$\frac{182}{\uparrow \uparrow} \Rightarrow 1800\text{ohm}=1.8\text{kohm}$   
 Indicates number of zeros after effective number.  
 2-digit effective number.

$\frac{1R2}{\uparrow \uparrow} \Rightarrow 1.2\text{ohm}$   
 1-digit effective number.  
 2-digit effective number, decimal point indicated by R.  
 : Units: ohm

● **Capacitors**

Ex.:      CE      04W      1H      3R2      M      BP

Type      Shape and performance      Dielectric strength      Capacity      Allowable error      Others

CE : Aluminum foil electrolytic	0J : 6.3 V	F : ±1%	HS : High stability type
CA : Aluminium solid electrolytic	1A : 10 V	G : ±2%	BP : Non-polar type
CS : Tantalum electrolytic	1C : 16 V	J : ±5%	HR : Ripple-resistant type
CQ: Film	1E : 25 V	K : ±10%	DL : For change and discharge
CK : Ceramic	1V : 35 V	M : ±20%	HF : For assuring high frequency
CC: Ceramic	1H : 50 V	Z : ±80%	U : UL part
CP: Oil	2A : 100 V	- : -20%	C : CSA part
CM: Mica	2B : 125 V	P : +100%	W : UL-CSA part
CF : Metallized	2C : 160 V	C : ±0.25pF	F : Lead wire forming
CH : Metallized	2D : 200 V	D : ±0.5pF	
	2E : 250 V	= : Others	
	2H : 500 V		
	2J : 630 V		

\* Capacity (electrolyte only)

$\frac{222}{\uparrow \uparrow} \Rightarrow 2200 \mu F$   
 Indicates number of zeros after effective number.  
 2-digit effective number.  
 · Units:  $\mu F$ .

$\frac{2R2}{\uparrow \uparrow} \Rightarrow 2.2 \mu F$   
 1-digit effective number.  
 2-digit effective number, decimal point indicated by R  
 · Units:  $\mu F$ .

\* Capacity (except electrolyte)

$\frac{222}{\uparrow \uparrow} \Rightarrow 2200\text{pF}=0.0022 \mu F$   
 Indicates number of zeros after effective number. (More than 2)  
 2-digit effective number.  
 · Units:pF

$\frac{221}{\uparrow \uparrow} \Rightarrow 220\text{pF}$   
 Indicates number of zeros after effective number. (0 or 1)  
 2-digit effective number.  
 · Units:pF

· When the dielectric strength is indicated in AC,"AC" is included after the dielectric strength value.



# WARNING AND LASER SAFETY INSTRUCTIONS

## **GB** WARNING

All ICs and many other semi-conductors are susceptible to electrostatic discharges (ESD). Careless handling during repair can reduce life drastically.

When repairing, make sure that you are connected with the same potential as the mass of the set via a wrist wrap with resistance.

Keep components and tools also at this potential.

ESD



## **NL** WAARSCHUWING

Alle IC's en vele andere halfgeleiders zijn gevoelig voor elektrostatische ontladingen (ESD).

Onzorgvuldig behandelen tijdens reparatie kan de levensduur drastisch doen verminderen.

Zorg ervoor dat u tijdens reparatie via een polsband met weerstand verbonden bent met hetzelfde potentiaal als de massa van het apparaat.

Houd componenten en hulpmiddelen ook op hetzelfde potentiaal.

## **F** ATTENTION

Tous les IC et beaucoup d'autres semi-conducteurs sont sensibles aux décharges statiques (ESD).

Leur longévité pourrait être considérablement écourtée par le fait qu'aucune précaution n'est prise à leur manipulation.

Lors de réparations, s'assurer de bien être relié au même potentiel que la masse de l'appareil et enfiler le braceleterti d'une résistance de sécurité.

Veiller à ce que les composants ainsi que les outils que l'on utilise soient également à ce potentiel.

## **D** WARNUNG

Alle IC und viele andere Halbleiter sind empfindlich gegen elektrostatische Entladungen (ESD).

Unvorsichtige Behandlung bei der Reparatur kann die Lebensdauer drastisch vermindern. Sorgen sie dafür, das Sie im Reparaturfall über ein Pulsarmband mit Widerstand mit dem Massepotential des Gerätes verbunden sind.

Halten Sie Bauteile und Hilfsmittel ebenfalls auf diesem Potential.

## **I** AVVERTIMENTO

Tutti IC e parecchi semi-conduttori sono sensibili alle scariche statiche (ESD).

La loro longevita potrebbe essere fortemente ridatta in caso di non osservazione della piu grande cauzione alla loro manipolazione.

Durante le riparazioni occorre quindi essere collegato allo stesso potenziale che quello della massa dell'apparecchio tramite un braccialetto a resistenza.

Assicurarsi che i componenti e anche gli utensili con quali si lavora siano anche a questo potenziale.

## **GB**

Safety regulations require that the set be restored to its original condition and that parts which are identical with those specified be used.

## **NL**

Veiligheidsbepalingen vereisen, dat het apparaat in zijn oorspronkelijke toestand wordt terug gebracht en dat onderdelen, identiek aan de gespecificeerde worden toegepast.

## **D**

Bei jeder Reparatur sind die geltenden Sicherheitsvorschriften zu beachten. Der Originalzustand des Gerats darf nicht verändert werden. Für Reparaturen sind Original-Ersatzteile zu verwenden.

## **I**

Le norme di sicurezza esigono che l'apparecchio venga rimesso nelle condizioni originali e che siano utilizzati pezzi di ricambio idetici a quelli specificati.

"Pour votre sécurité, ces documents doivent être utilisés par des spécialistes agréés, seuls habilités à réparer votre appareil en panne."

## **F**

Les normes de sécurité exigent que l'appareil soit remis à l'état d'origine et que soient utilisées les pièces de rechange identiques à celles spécifiées.

## LASER SAFETY

This unit employs a laser. Only a qualified service person should remove the cover or attempt to service this device, due to possible eye injury.



**USE OF CONTROLS OR ADJUSTMENTS OR PERFORMANCE OF PROCEDURE OTHER THAN THOSE SPECIFIED HEREIN MAY RESULT IN HAZARDOUS RADIATION EXPOSURE.**

**AVOID DIRECT EXPOSURE TO BEAM**

**WARNING**

**The use of optical instruments with this product will increase eye hazard.**

**Repair handling should take place as much as possible with a disc loaded inside the player**

**WARNING LOCATION: INSIDE ON LASER COVERSIELD**

**CAUTION** VISIBLE AND INVISIBLE LASER RADIATION WHEN OPEN AVOID EXPOSURE TO BEAM  
**ADVARSEL** SYNLIG OG USYNLIG LASERSTRÅLING VED ÅBNING UNDGÅ UDSÆTTELSE FOR STRÅLING  
**ADVARSEL** SYNLIG OG USYNLIG LASERSTRÅLING NÅR DEKSEL Å PNES UNNGÅ EKSPONERING FOR STRÅLEN  
**VARNING** SYNLIG OCH OSYNLIG LASERSTRÅLNING NÅR DENNA DEL ÅR ÖPPNAD BETRAKTA EJ STRÅLEN  
**VARO!** AVATT AESSA OLET ALTTIINA NÄKYVÄLLE JA NÄKYMÄTTÖMÄLLE LASER SÄTEILYLLE. ÄLÄ KATSO SÄTEESEEN  
**VORSICHT** SICHTBARE UND UNSICHTBARE LASERSTRAHLUNG WENN ABDECKUNG GEÖFFNET NICHT DEM STRAHL AUSSETZEN  
**DANGER** VISIBLE AND INVISIBLE LASER RADIATION WHEN OPEN AVOID DIRECT EXPOSURE TO BEAM  
**ATTENTION** RAYONNEMENT LASER VISIBLE ET INVISIBLE EN CAS D'OUVERTURE EXPOSITION DANGEREUSE AU FAISCEAU

# INSTRUCTIONS FOR HANDLING SEMI-CONDUCTORS AND OPTICAL UNIT

Electrostatic breakdown of the semi-conductors or optical pickup may occur due to a potential difference caused by electrostatic charge during unpacking or repair work.

## 1. Ground for Human Body

Be sure to wear a grounding band ( $1\text{ M}\Omega$ ) that is properly grounded to remove any static electricity that may be charged on the body.

## 2. Ground for Workbench

Be sure to place a conductive sheet or copper plate with proper grounding ( $1\text{ M}\Omega$ ) on the workbench or other surface, where the semi-conductors are to be placed. Because the static electricity charge on clothing will not escape through the body grounding band, be careful to avoid contacting semi-conductors with your clothing

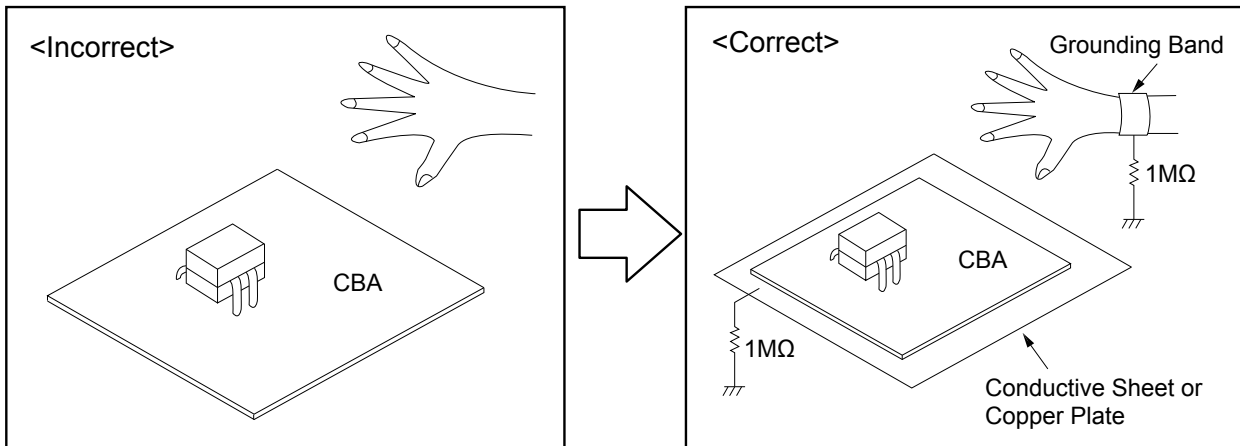

# TECHNICAL SPECIFICATIONS

## □ Audio performance

### • Analog output

	[Super Audio CD]	[CD]
<b>Channels:</b>	2 channels	2 channels
<b>Playable frequency range:</b>	2 Hz – 100 kHz	2 Hz – 20 kHz
<b>Playable frequency response:</b>	2 Hz – 50 kHz (-3 dB)	2 Hz – 20 kHz
<b>S/N:</b>	112 dB (Audible range)	110 dB
<b>Dynamic range:</b>	110 dB (Audible range)	100 dB
<b>Harmonic distortion:</b>	0.001 % (1 kHz, Audible range)	0.002 % (1 kHz)
<b>Wow &amp; flutter:</b>	Crystal accuracy	Crystal accuracy
<b>Output level</b>		
<b>Unbalanced:</b>	1.8V RMS stereo	2.4V RMS stereo
<b>Headphone output:</b>	43mW (variable maximum)	43mW (variable maximum)
<b>Digital output</b>		
<b>output level (cinch JACK):</b>	—	0.5 Vp-p (75 Ω)
<b>output level (optical):</b>	—	-19 dBm
<b>Optical Readout System</b>		
<b>Laser:</b>	AlGaAs	AlGaAs
<b>Wave length:</b>	650nm	780nm
<b>Signal type:</b>	1-bit DSD	16-bit linear PCM
<b>Sampling frequency:</b>	2.8224 MHz	44.1 kHz

## □ General

<b>Power supply (for U):</b>	AC 120 V, 60 Hz
<b>Power supply (for N):</b>	AC 230 V, 50 Hz/60 Hz
<b>Power supply (for K):</b>	AC 220 V, 50 Hz
<b>Power consumption:</b>	25 W
	Standby: 0.3 W or less
<b>Maximum external dimensions:</b>	440 (W) x 109 (H) x 344 (D) mm
<b>Weight:</b>	7.8 kg
<b>Operating temperatures:</b>	+5°C ~ +35°C
<b>Operating humidity:</b>	5 ~ 90% (without dew)

## DIMENSION

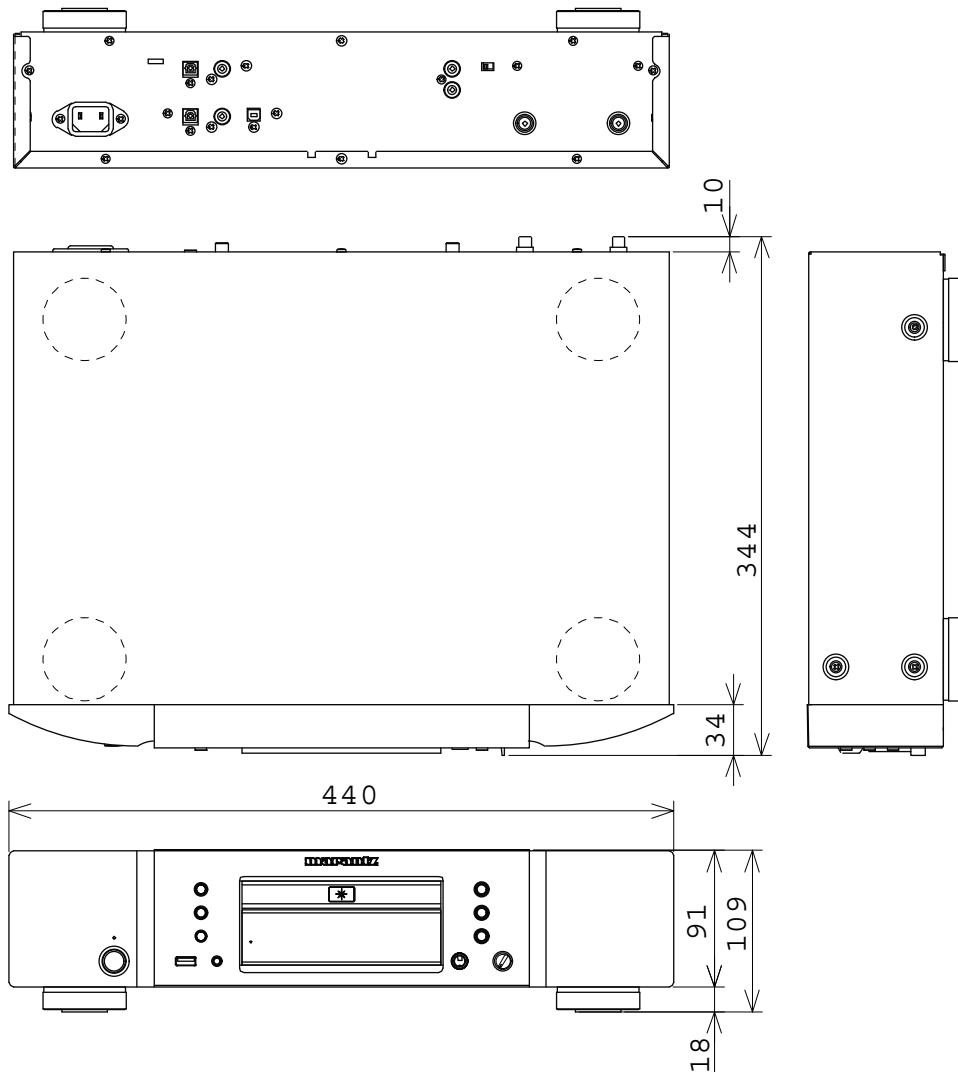

# CAUTION IN SERVICING

## Initializing Super Audio CD player

Initialize the Super Audio CD player when  $\mu$ com, peripheral parts of  $\mu$ com, or MAIN P.W.B. unit has been replaced in servicing.

To reset the back up memory of the unit into the default status, follow the procedure below.

1. Turn on the unit and press ■ and ON/STANDBY button simultaneously more than 3 seconds.
2. "Reset" is displayed, after "Reset OK" displayed on the display, and EEPROM is cleared to the default status, microprocessor is reset and unit returns to the normal status.

**Note:** •If step 2 does not work, start over from step 1.  
•All user settings will be lost and this factory setting will be recovered when this initialization mode.  
So make sure to memorize your setting for restoring after the initialization.

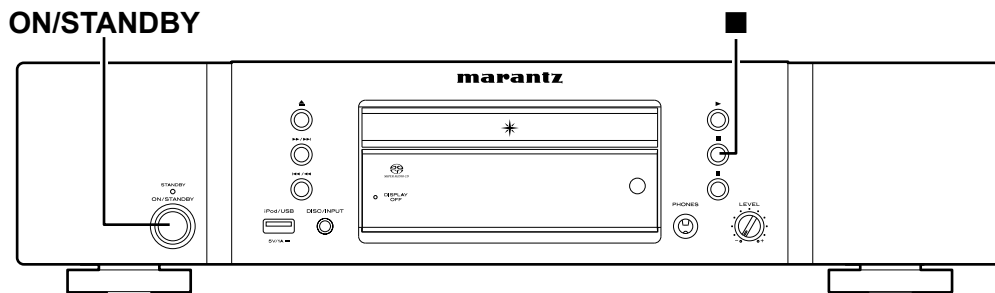

## Service tools

Measuring Disc: CD/TCD-784  
SBC444A or TCD-726

\* Refer to "MEASURING METHOD AND WAVEFORMS".

## Service Jigs

When you update the firmware, you can use the following  
Please order to marantz Official Service Distributor in your region if necessary.

8U-210100S : WRITING KIT : 1 Set

\* Refer to "VERSION UPGRADE PROCEDURE OF FIRMWARE".

# DISASSEMBLY

- Disassemble in order of the arrow of the figure of following flow.
- In the case of the re-assembling, assemble it in order of the reverse of the following flow.
- In the case of the re-assembling, observe "attention of assembling" it.
- If wire bundles are untied or moved to perform adjustment or parts replacement etc., be sure to rearrange them neatly as they were originally bundled or placed afterward.  
Otherwise, incorrect arrangement can be a cause of noise generation.

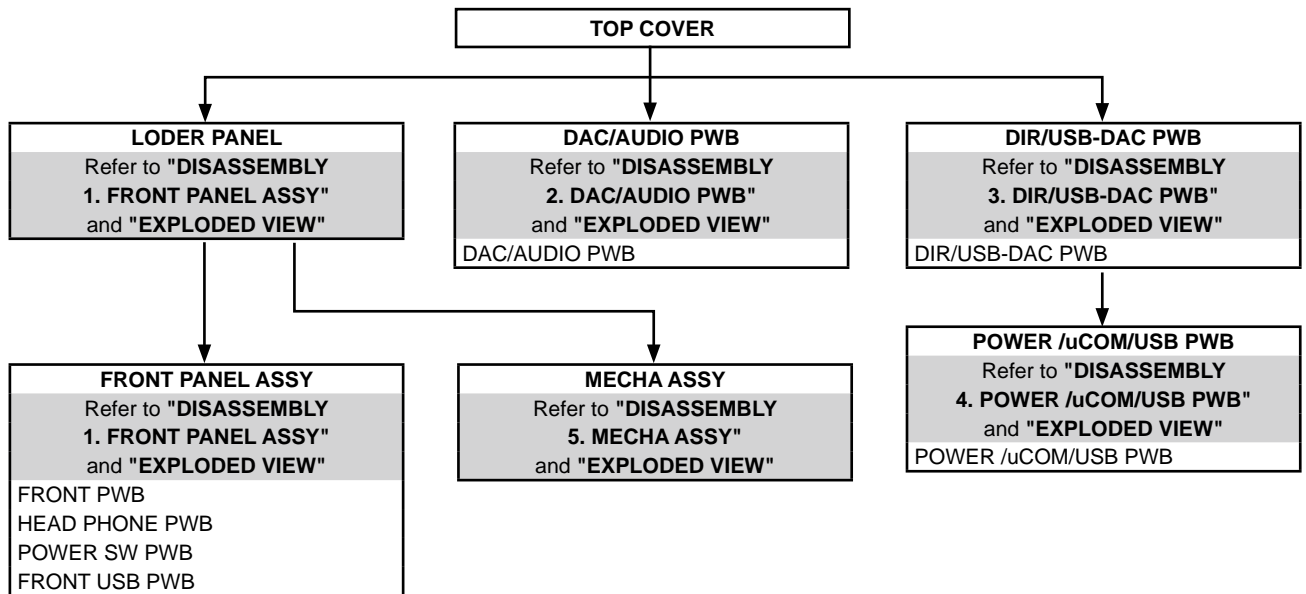

## About the photos used for descriptions in the "DISASSEMBLY" section.

- The direction from which the photographs used herein were photographed is indicated at "Direction of photograph: \*\*\*\*" at the left of the respective photographs.
- Refer to the table below for a description of the direction in which the photos were taken.
- Photographs for which no direction is indicated were taken from above the product.
- The photograph is SA8004 K1SG model.

### The viewpoint of each photograph (Photography direction)

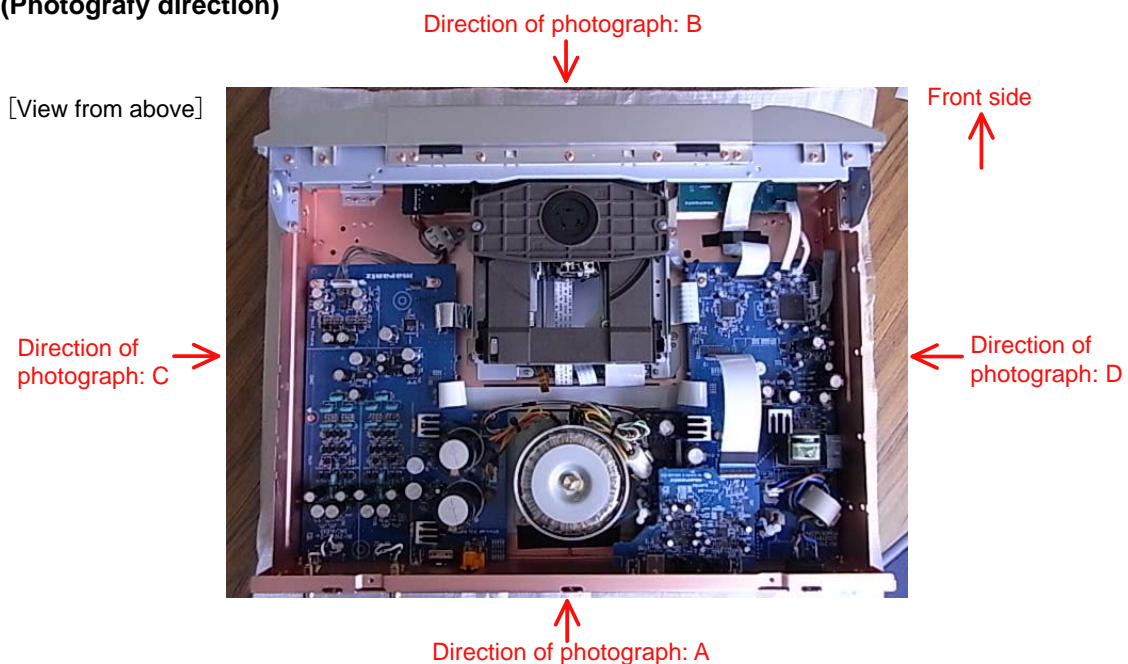

## 1. FRONT PANEL ASSY

Proceeding : **TOP COVER** → **LOADER PANEL** → **FRONT PANEL ASSY**

(1) Detach the DOOR.

Direction of photograph: B



(2) Remove the screws.

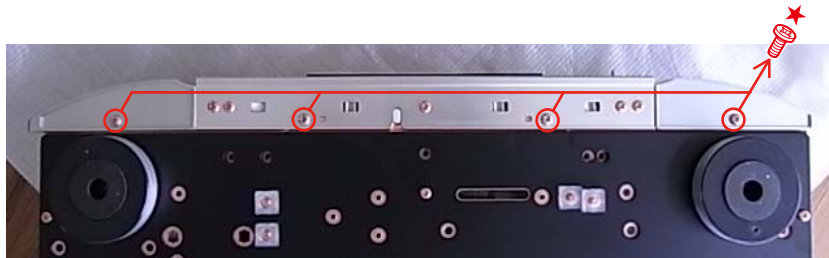

(3) Disconnect the connector wires and FFC cables, then remove the screws.

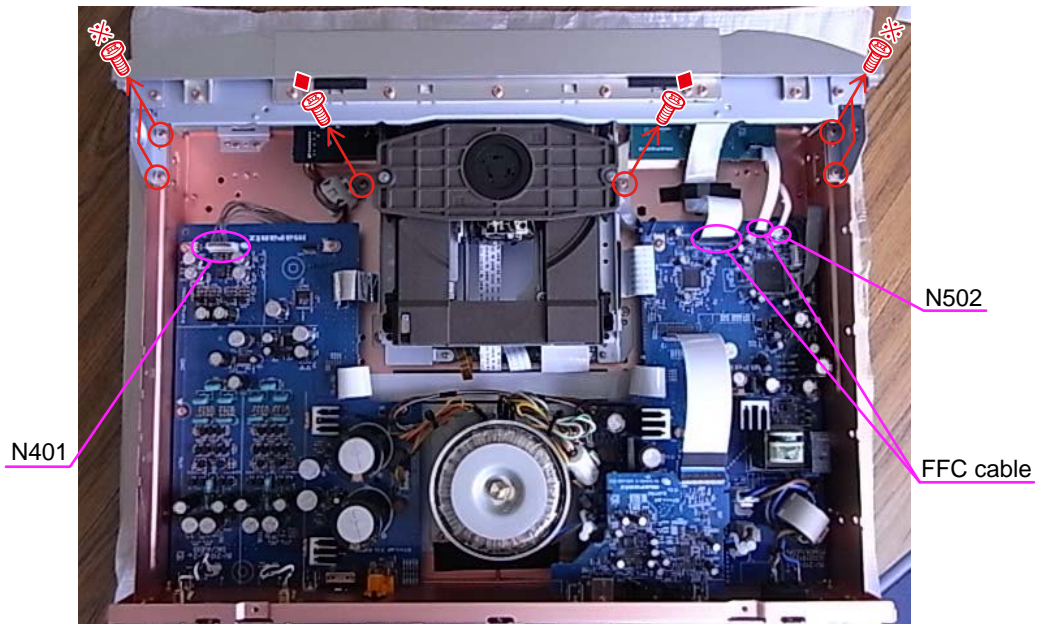

Please refer to "EXPLODED VIEW" for the disassembly method of each P.W.B included in FRONT PANEL ASSY.

## 2. DAC/AUDIO PWB

Proceeding : **TOP COVER** → **DAC/AUDIO PWB**

(1) Remove the screws.

Direction of photograph: A

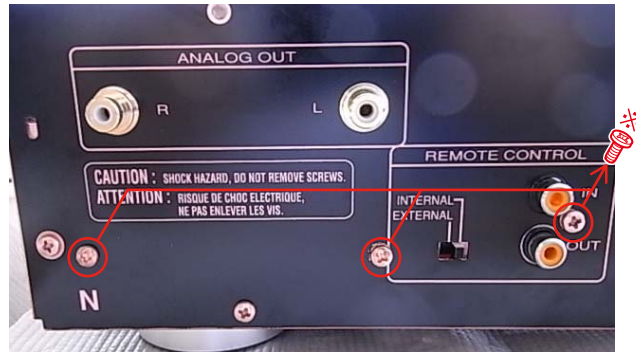

(2) Disconnect the connector wires and FFCs cable, then remove the screws.

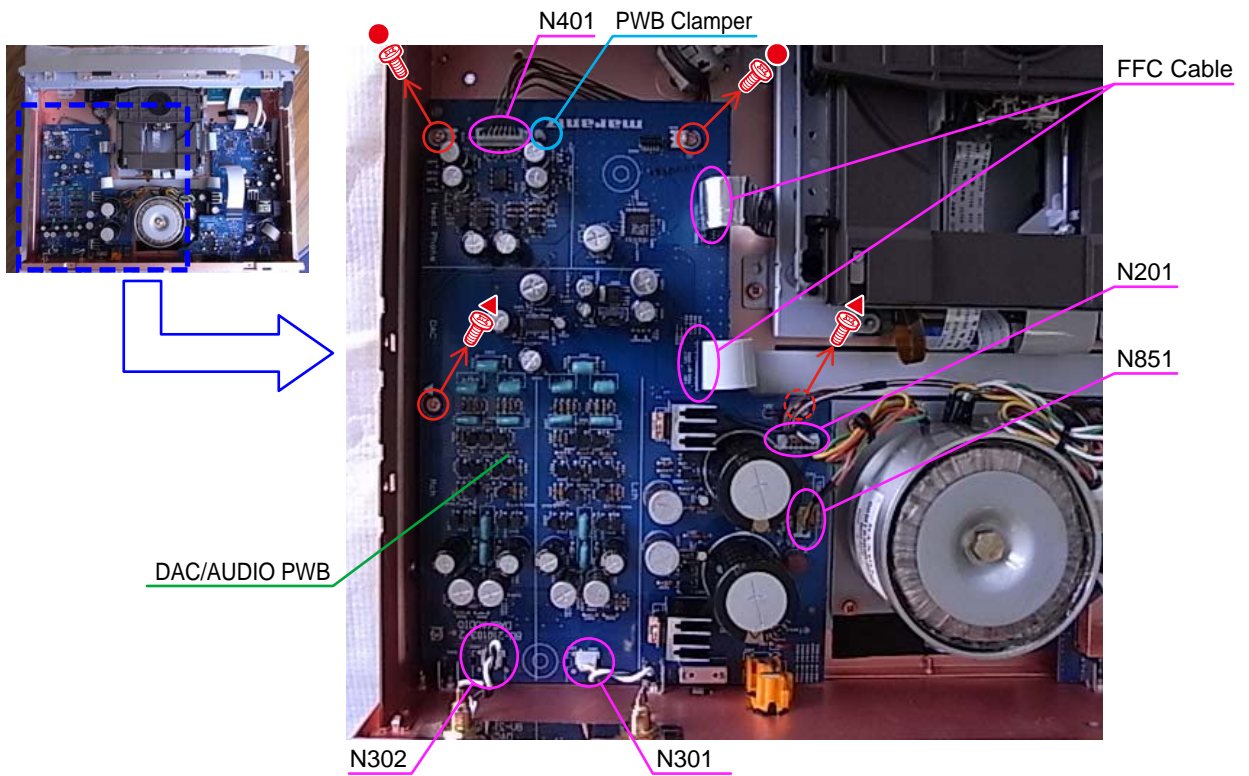



### 3. DIR/USB-DAC PWB

Proceeding : **TOP COVER** → **DIR/USB-DAC PWB**

(1) Remove the screws.

Direction of photograph: A

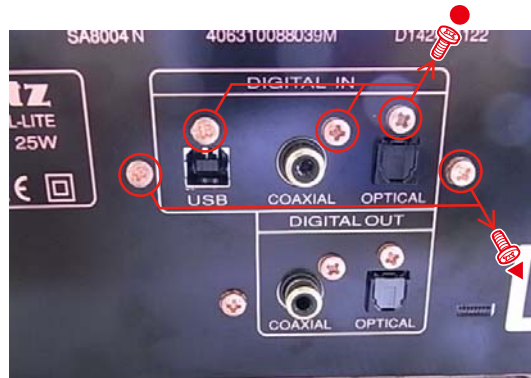

(2) Disconnect the FFC cable.

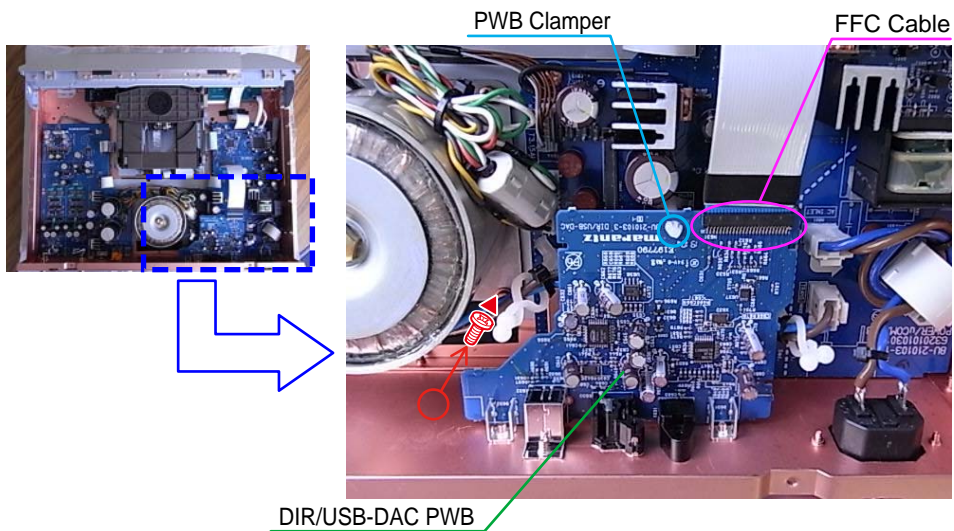



#### 4. POWER/uCOM/USB PWB

Proceeding : **TOP COVER** → **POWER/uCOM/USB PWB**

(1) Remove the screws.

Direction of photograph: A



(2) Disconnect the connector wires and FFC cables, then remove the screws.

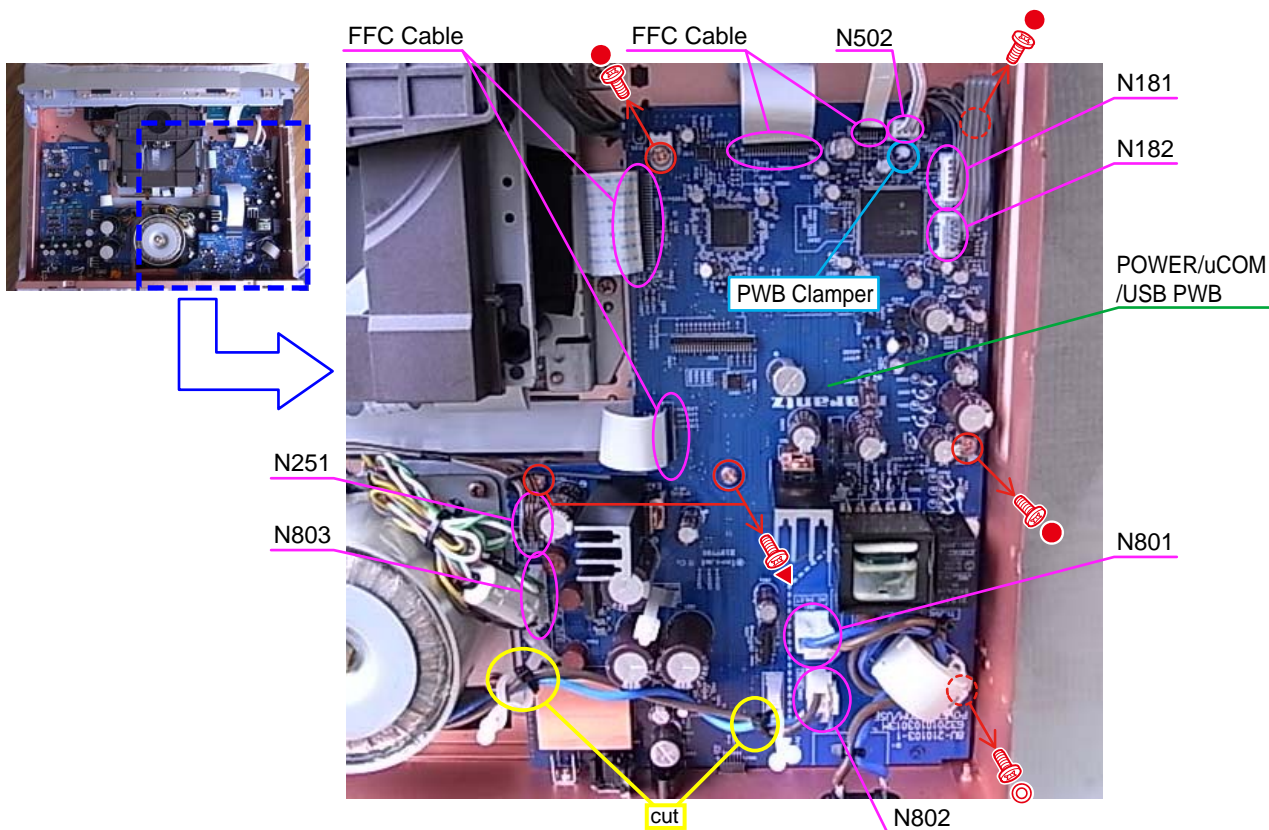

## 5. MECHA ASSY

Proceeding : **TOP COVER** → **LOADER PANEL** → **MECHA ASSY**

(1) Remove the screws.

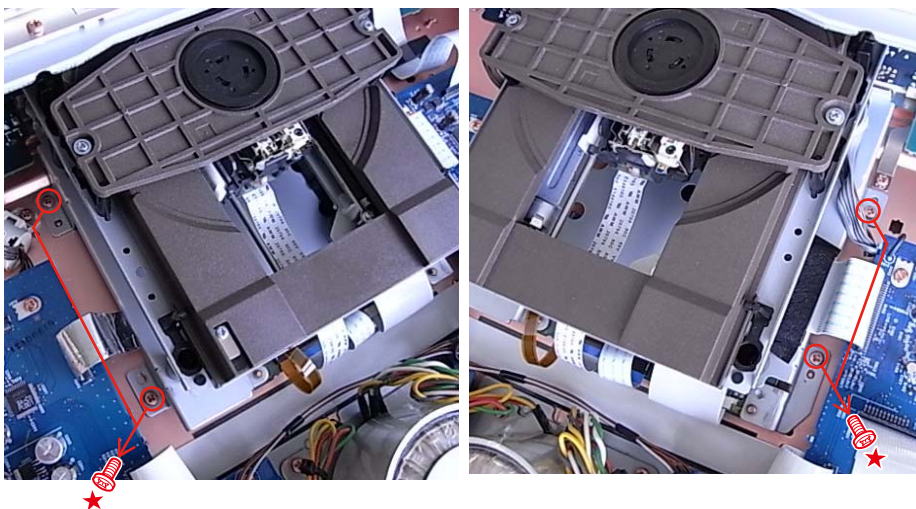

(2) Disconnect the connector wires and FFC cables.

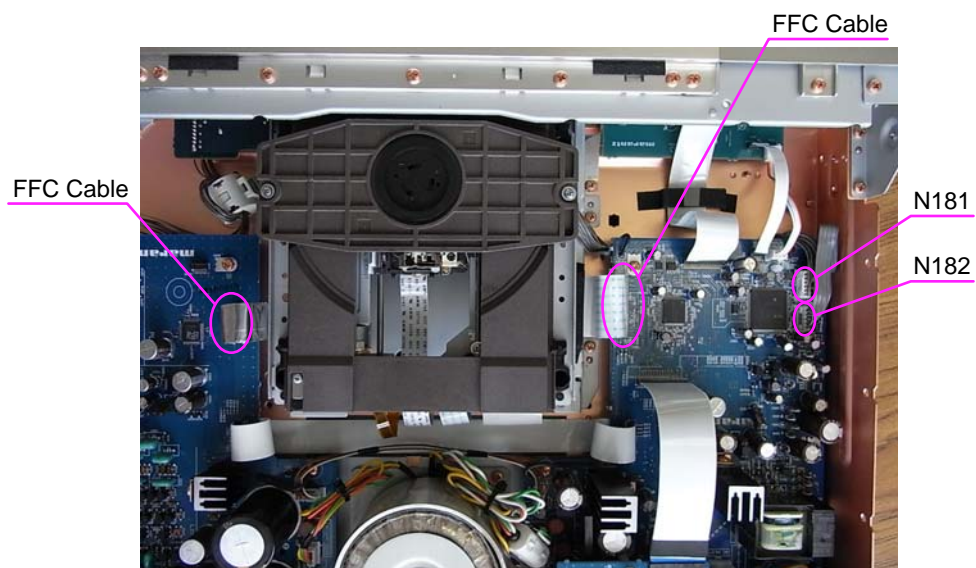

## CAUTIONS IN ASSEMBLING AND DISASSEMBLING

When removing the FFC (flexible flat cable), connecting the optical pick up and the Super Audio CD PWB, short the short three lands pointed by the arrow with solder. Otherwise the laser diode may be damaged by static electricity

※ Be sure to wear a grounding band.

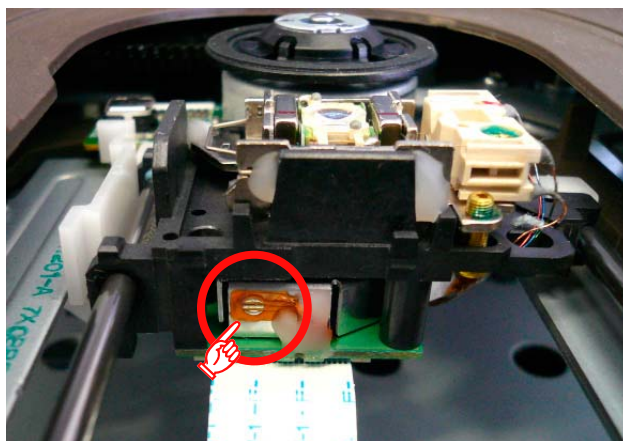
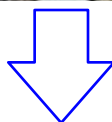
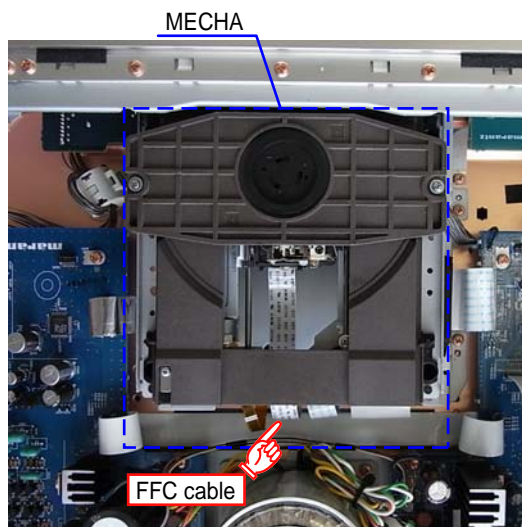

Short the three short lands by soldering.

## REMOVING DISCS

- (1) Remove the Top Cover.
- (2) Remove the screws.

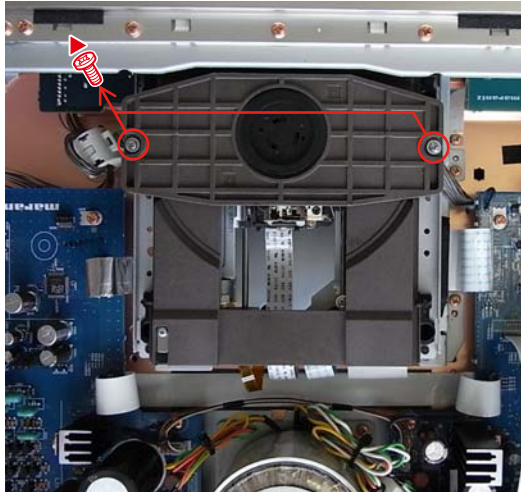

- (3) Remove the disc clumper.
- (3) Now you can remove the disc.

# SERVICE MODE

- (1) Insert mains cable plug in the outlet. (The Unit is standby mode.)
- (2) Press the ON/STANDBY button While pressing ►►►►I and ■ button.

Model name is displayed.

**SA8004**

- (3) Press ►►►►I button ↓      ↑ Press ◀◀◀◀I◀◀◀◀ button

Version of FRONT microprocessor is displayed.

**FR2010062501**

- (4) Press ►►►►I button ↓      ↑ Press ◀◀◀◀I◀◀◀◀ button

Number of SA-CD module ROM is displayed.

**SROM : AYW7260**

- (5) Press ►►►►I button ↓      ↑ Press ◀◀◀◀I◀◀◀◀ button

Version of SA-CD module ROM is displayed.

**SVer : 1.21**

- (6) Press ►►►►I button ↓      ↑ Press ◀◀◀◀I◀◀◀◀ button

Revision of USB module LSI is displayed.

**uPD63901\_501**

- (7) Press ►►►►I button ↓      ↑ Press ◀◀◀◀I◀◀◀◀ button

Revision of USB module LSI is displayed.

**UVer : V.111**

- (8) Press ►►►►I button ↓      ↑ Press ◀◀◀◀I◀◀◀◀ button

The segment of the character aria and the label are in FLD light on and off each other.

▶	1	OPT	RNDM	PROG	TRK	SA-CD	CD	M FILE	USB	DOFF	REMAIN	TTL
■	■	■	■	■	■	■	■	■	■	■	■	■

- (9) Press ►►►►I button ↓      ↑ Press ◀◀◀◀I◀◀◀◀ button

Turn off all FL segments.

- (10) Press ►►►►I button ↓      ↑ Press ◀◀◀◀I◀◀◀◀ button

Serial number is displayed.

MZ\_XXXXXXXX

(11) Press ►►►/►►►I button ↓      ↑ Press ◀◀◀/I◀◀◀ button

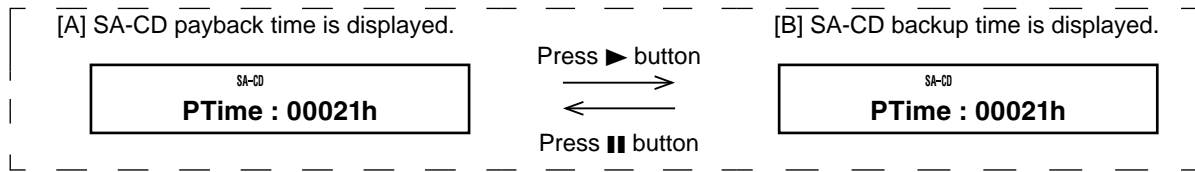

(12) Press ►►►/►►►I button ↓      ↑ Press ◀◀◀/I◀◀◀ button

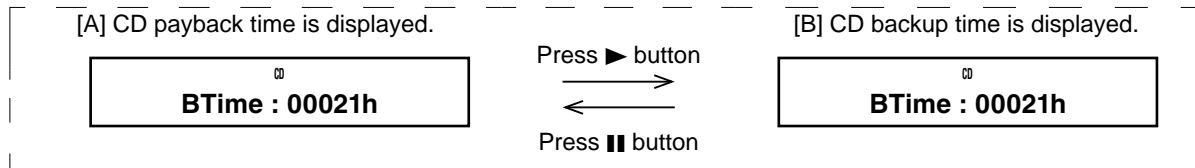

Backup time (BTime) :

When replacing SA-CD module and reset playback times (total), the software is available that automatically backs up (saves) playback times (total). You can check the information before replacing SA-CD module.

Press the ON/STANDBY button to quit Service Mode.

### Factory Mode

To reset the back up memory of the unit into the default status, follow the procedure below.

- (1) Turn on the unit and press ■ and ON/STANDBY button simultaneously more than 3 seconds.
- (2) "Reset" is displayed, after "Reset OK" displayed on the display, and EEPROM is cleared to the default status, microprocessor is reset and unit returns to the normal status.



## HOW TO THE RESET OF PLAYBACK TIME

When replacing CD MECHANISM [ 001M or M002 ] (TRAVERSE Block), please reset Playback time (total) in the following procedure.

- (1) Procedure 11, 12 of SERVICE MODE, Playback time (total) is displayed.

**PTime : 10051h**

The display is a time unit. (Example: "10050 hours, 0 minute, 1 second" is 10051h)  
The maximum Playback time is 65536h.

- (2) Press ■ button 3 seconds and more. PTime Clear? is displayed.

**PTime Clear?**

- (3) Press ► button. Done is displayed after PTime:00000h is displayed. Play back time (total) was reset.

**Done : xxx**



**PTime : 00000h**

When the I◀◀/◀◀ button is pushed during a "PTime:00000h" display, it will return to the beginning (Model name is displayed) in service mode.

Press the ON/STANDBY button to quit Service Mode.

# ERROR MESSAGE

This test mode is common to all models.

**[A] The mode to check the last error message etc.**

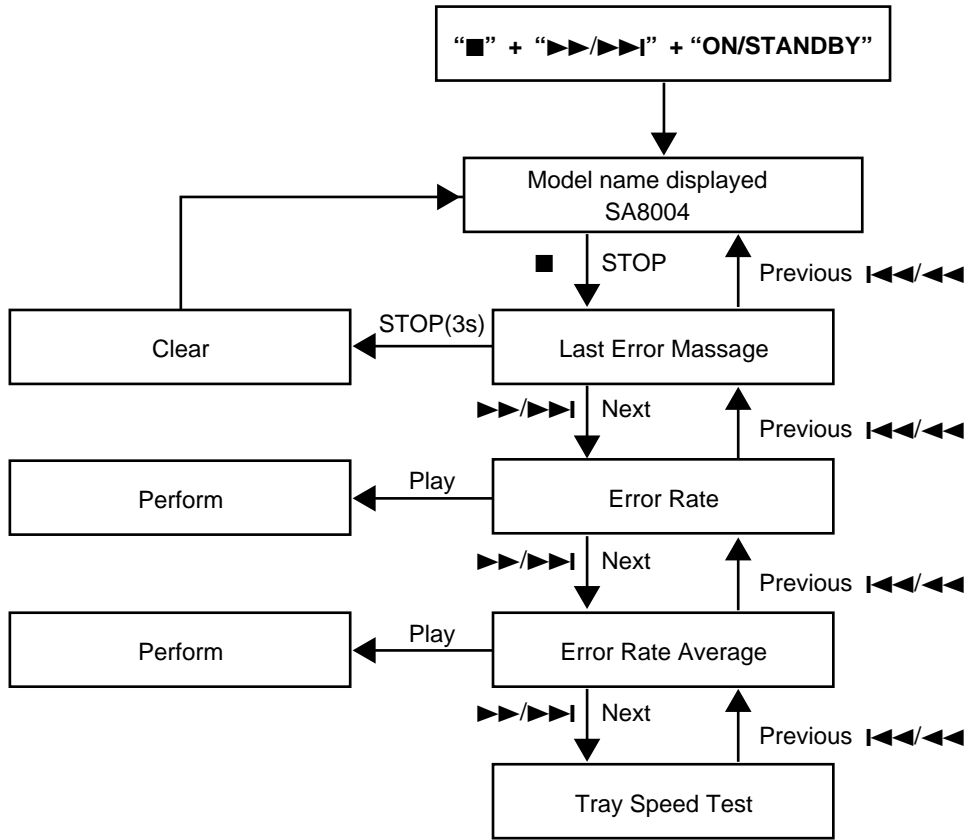

Here is the indication and specification of each function.

## 1. Last Error Message

This function enables the users to check error messages at a later time when an error has occurred between the front microprocessor and each device.

However, it does not display all errors. For more information about what messages can be displayed, refer to the **[B] Other Error Message page**. When no error has ever occurred, it displays the following.



Hold the ■ button for 3 seconds while the last error message is being displayed, and the last error message will be cleared. After the last error message is cleared, the model identification returns to the display.



## 2. Error Rate

This function determines the CD error rate. For SA-CDs, it only displays reference values.

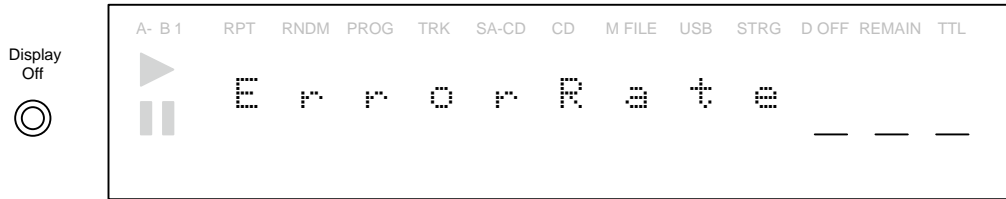

The buttons that function while this message is being displayed are ▲ and ►. (NEXT/PREVIOUS is functional too but switches to another service mode.)

Press the ▲ button, put in a disc to determine and press ► button to start playback. When the playback has begun, the display message will be switched to the following:

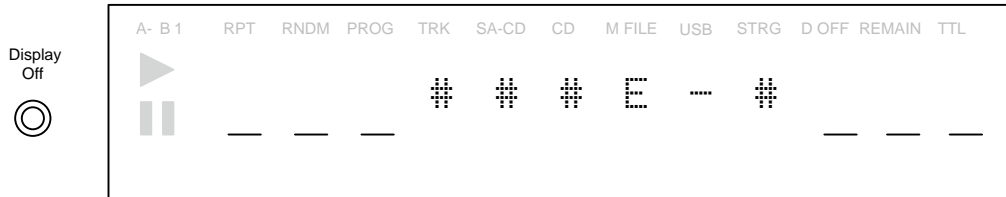

A current error rate will be displayed for approximately 3 seconds.

The above message "###E-#" will, for example, be "173E-4" in case of 1.73 / 10000 (173ppm).

If the displayed value will not change, the processing may have failed. Please take out the disc and repeat the procedure again. Using the same disc will not always means that the same value will be displayed.

## 3. Error Rate Average

This function determines the CD error rate and displays an average value of the first several rates.

For SA-CDs, it only displays reference values.



The buttons that function while this message is being displayed are ▲ and ►. (NEXT/PREVIOUS is functional too but switches to another service mode.)

Press the ▲ button, put in a disc to determine and press ► button to start playback. When the playback has begun, the display message will be switched to the following:

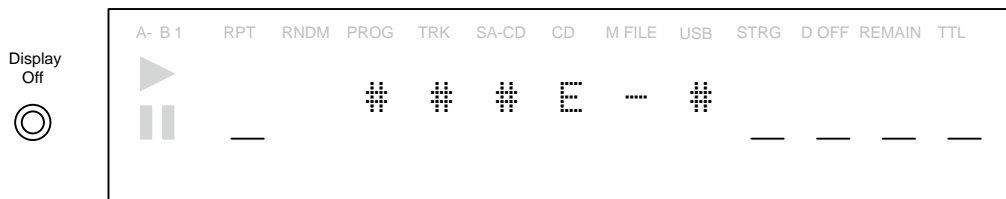

A current error rate will be displayed for approximately 3 seconds.

The above message "###E-#" will, for example, be "173E-4" in case of 1.73 / 10000 (173ppm).

If the displayed value will not change, the processing may have failed. Please take out the disc and repeat the procedure again. Using the same disc will not always means that the same value will be displayed.

When an average has been calculated after a predetermined number of times of measurement, the displayed message will be switched to the following:

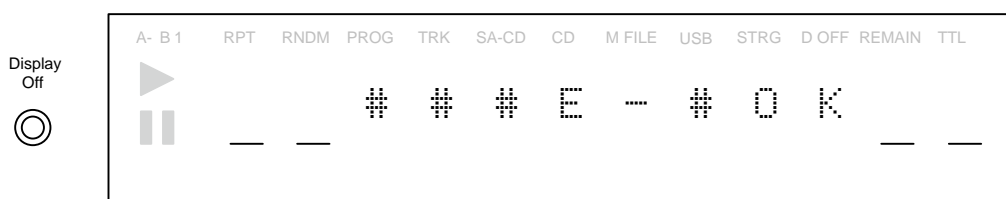

#### 4. Tray Speed Test

This function allows the OPEN/CLOSE speed of the tray to be variable. It can be changed at a 1% step to the default values. Here are default values:

	1	2	3	4	5
Time	0-500ms	500ms-1s	1s-1.5s	1.5s-2s	2s~
TRY_OPN	85 %	65 %	55 %	55 %	55 %
TRY_CLS	65 %	70 %	75 %	85 %	100 %

Once into the test mode, it will display the following message:

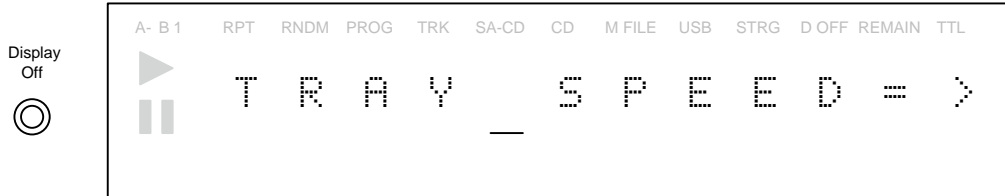

Press the **■** button, and it will enable the number after Open to be variable (between 0 and 500ms).



Press the **▶** button, and the number goes up at a 1% step; press the **||** button, and the number goes down at 1% step.

Press the **■** button at any value, and the setting for "Open1" will be determined (between 0 and 500ms). Once the setting is determined, it will automatically determine the setting for "Open2".

Likewise, determine the setting for each of Open2 to Open5 and then for each of Close1 to Close5.

When the Close5 setting is completed, the display will show the following message:

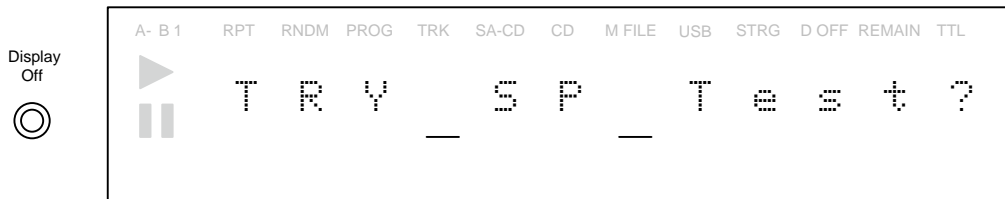

Then, press the **■** button, and the OPEN/CLOSE operation will be repeated three times at the set speed. Meanwhile, press the **▶** button while this message is on the display, and the OPEN/CLOSE test will be cancelled and the model indication will return to the display. However, the setting has been memorized so that the speed will remain unchanged.

Also, press the **||** button while this message is on the display, and the OPEN/CLOSE test will be cancelled, the model indication will return and the setting will be cancelled.

When the OPEN/CLOSE test is performed with the operation repeated three times, the display will show the following message:

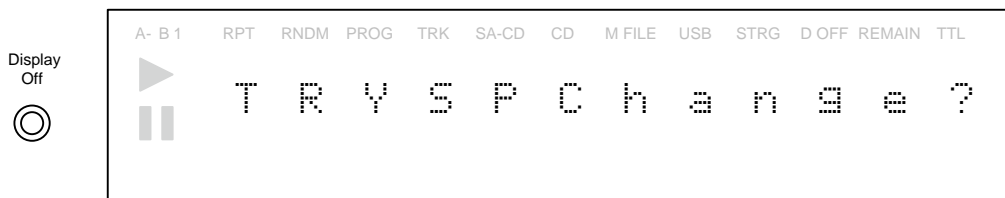

Press the **■** button then, and the model identification will return, and the OPEN/CLOSE will be performed at the set speed.

If another button is pressed, the setting will be cancelled and the model identification will return.

## [B] The mode to check the last error message etc.

This test mode is common to all models.

### 1. The error message displayed as the Last Error Message

#### (1) Communication error between SA-CD Module and Microprocessor

When having had the communication error with the SA-CD Module more than a regulated number of times, the unit will reset the SA-CD Module after displaying the following message. This will continue to be displayed until the unit has recovered from the communication error.

When the unit is ready to play back CDs and SA-CDs, the SA-CD Module and the Microprocessor communicate regularly. Check the signal in reference to the communication between the SA-CD Module and the Microprocessor on Communication Waveforms page.

The MOD\_SCL is the clock that is transmitted from the SA-CD regularly. If this signal cannot be detected, the SA-CD Module may be broken. If so, replace the SA-CD Module.

When the SA-CD Module has been replaced, ensure that the Playtime will be cleared.

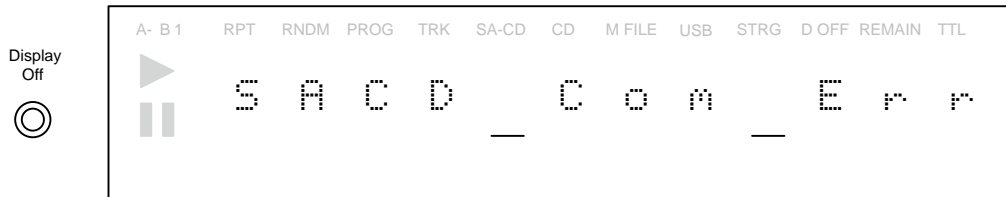

#### (2) Communication Error between D/A Converter and Front Microprocessor

If no response is detected in the communication between the D/A Converter and the Microprocessor, the display will show the following message. Make the CD/SA-CD or the USB replayable.

Ensure that IIC communications have been established between R217 and R218 when the unit is switched from STOP to PLAY.

If the error cannot be corrected through normal operations, U204 may be broken. If such is the case, replace U204.



### 2. Error messages that are not displayed in the Last Error Message

#### (1) Error messages that can be displayed on the FL

(Communication Error between the Front Microprocessor and EEPROM)

If no response is detected between the Front Microprocessor and EEPROM within a regulated timeframe, the display will show the following message.

Ensure that IIC communications have been established between R123 and R125 when the unit is powered on or put into STANDBY.

If the error cannot be corrected through normal operations, U101 may be broke. If such is the case, replace U101.



When no disc information is displayed 120 seconds after the disc is loaded, the display will show the following message. Reset the SA-CD Module.

If no information can be obtained after this operation has been repeated three times, the unit will open the tray by itself. The unit cannot play back the disc if this message appears.

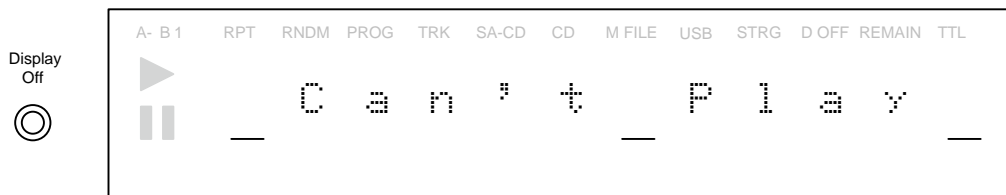

## [C] Error Messages special to USB

### 1. Error Message displayed as the Last Error Message

If no response is made in the communication between the USB Module U501 and the microprocessor within a designated timeframe, the display will show the following message.

Refer to the Communication between USB Module and the microprocessor on the Communication Waveform page and check the signal.

If the error message below cannot be cleared despite the unit performing normal operations properly, U501 may be broken. If such is the case, replace U501.



If no response is made in the communication with an iPod-authenticated IC within a regulated timeframe, the display will show the following message.

As the communication with the authenticated IC has not been established normally, ensure that the IIC signal is communicating at a normal level when the unit is connected with an iPod.

The frequency of the IIC clock (IIC\_SCL) is approximately 40 kHz only when the unit communicates with an iPod-authenticated IC.

If no communication can be detected, check the soldering points of the microprocessor (U102), resistors (R155, R157) and the authenticated IC (U151).

If the problem specific to the iPod cannot be rectified, the authenticated IC (U151) may be broken. If that is the case, replace U151.



When the iPod-authenticated IC has received error information, the display will show the following message. This message means that the authenticated IC is communicating properly. Try connecting another iPod. If no problem arises with another iPod, advise the user to repair the iPod.

If the same problem arises with another iPod, the authenticated IC (U151) may be broken. If that is the case, replace U151.



When a problem arises with the processing of the iPod authentication and signature, the display will show the following message.

If the following message appears instead of the above messages - "iPodErrorIC", "iPodICErrorx" and "USB\_Com\_Error\_", try connecting another iPod.

If no problem arises, advise the user to repair the iPod.

If the error message persists, the authenticated IC (U151) may be broken. If that is the case, replace U151.

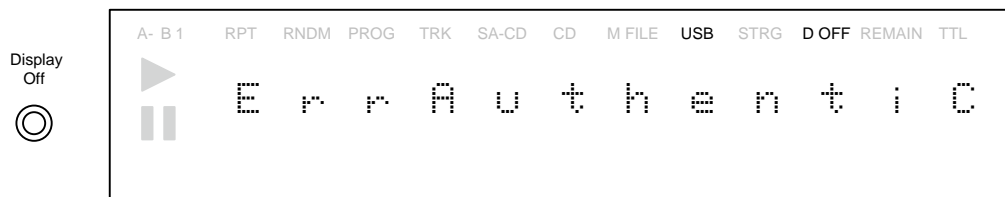

## 2. Error Message not displayed as the Last Error Message

### (1) Error Message that is displayed when UBS memories and USB HDD are used

If no response is made while the unit is communicating with the USB Module, the display will show the following message.

If the indication is not changed to "USB\_Com\_Err", the communication may be unstable.

Refer to the communication between the USB module and the microprocessor on the communication waveform page and check the signal.

If the message below cannot be cleared while the unit is functioning normally, U501 may be broken. If that is the case, replace U501.



When the unit is connected with an incompatible UBS device or a device configured with an incompatible communication protocol or command, the display will show the following message.

If this message is displayed, the device is incompatible and cannot be connected to the unit.

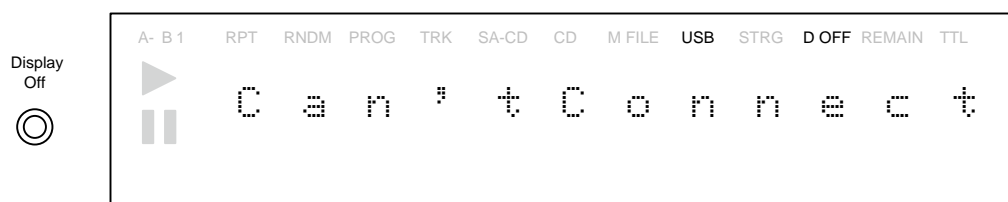

If the information obtained from the USB has a flaw or improper data, which are detected by the USB host controller in the unit, the display will show the following message.

When the message appears, the device may be connected and used, but success is not guaranteed.

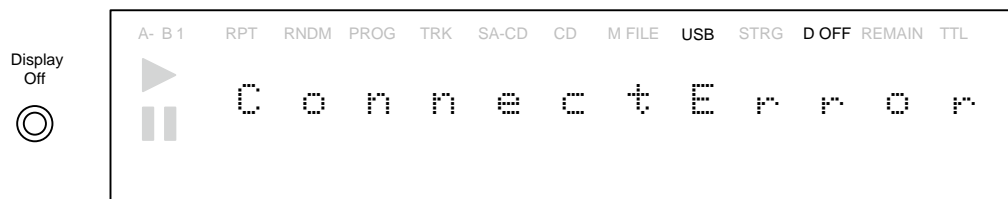

If the signal comes in an incompatible format, the display will show the following message.

The compatible formats are FAT16 and FAT32. In FAT32 the USB memory must be 128MB or bigger in size.

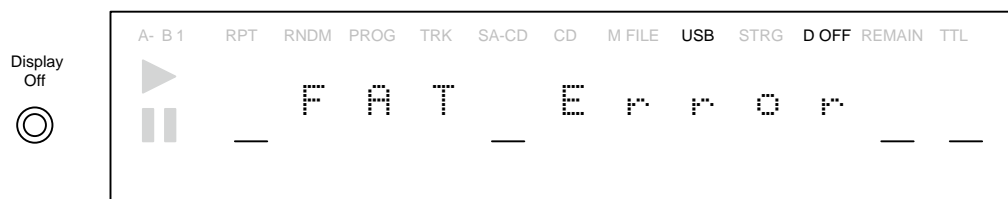

This message means that the device is formatted in an incompatible cluster size. Normally, when USB memories are formatted on Microsoft Windows, FAT32 is the default, and if the memory size is up to 128MB, it will be formatted in a cluster size of 2KB, which is incompatible with the unit. Therefore, the memory size is recommended to be 256MB or bigger. If the memory size is 128MB, format it with FAT16 (indicated as FAT on Microsoft Windows) instead of FAT32, and it will be compatible with the unit.

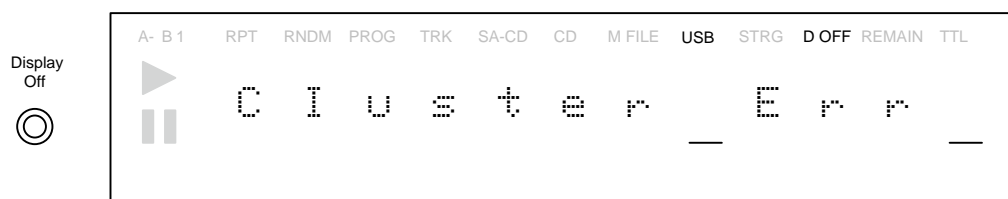

If no playable file exists in the USB device connected to the unit, the display will show the following message:

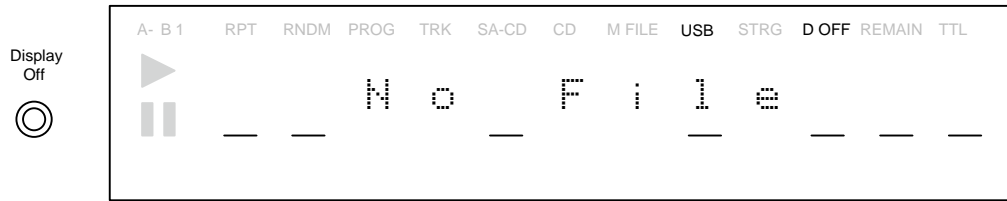

If the unit receives a power supply exceeding the maximum level (1 A) via USB, the display will show the following message and the power supply will be cut off. If the message below appears, the USB device cannot be operated through the unit's USB Bus power alone. An auxiliary power unit might enable the device to be used, but damage resulting from this would not be covered by the warranty.

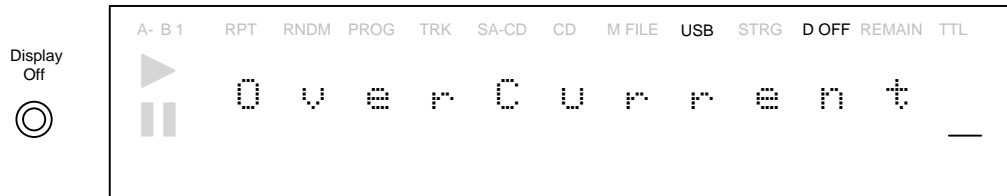

If the command will not be set within a set timeframe after PLAY, PAUSE, STOP, FF, FR and such operations are carried out, the display will show the following message.

This message will be displayed for 3 seconds and then the USB module will be reset.

If the error indication persists after these operations, U501 may be broken as the unit will not accept a specific command alone. If no other error message will appear, replace U501.



If the file has an incompatible extension or is 24KB or smaller in size, the display will show the following message. Extensions other than those mentioned in the instructions manual will be excluded from the warranty. Refer to the instructions manual and ensure that the extension and format is compatible with the unit.



If the unit detects an incompatible sampling frequency or number of channels or an incompatible format file, the display will show the following message.

Sampling frequencies, numbers of channels and formats other than those mentioned in the instructions manual will be excluded from the warranty. Refer to the instructions manual and ensure that the format is incompatible.



If the unit detects a DRM protected file, the display will show the following message.

The unit is not made to and hence cannot play back DRM protected files.



If the unit detects a file with corrupted file data or other unacceptable files, the display will show the following message.

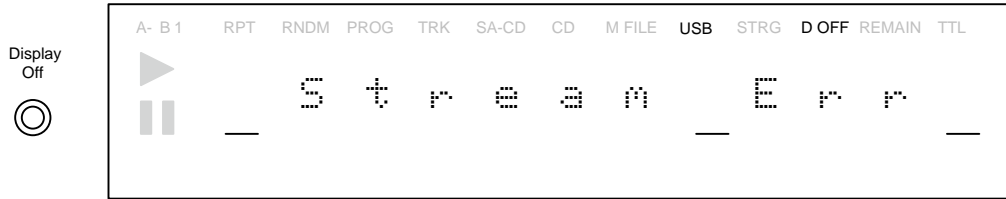

If the file includes big sized image data or information, the analysis may take time. If the analysis takes more than 15 seconds, the display will show the following message.

If this message appears, the operation of the file will not be covered by the warranty.



If the USB module turns off the command for the settings of AMS, Repeat or Random, the display will show the following message.

If the error persists after the mode is switched to Disc from USB and then reswitched to USB and the designated remote control code is sent, U501 may be broken as it will not accept a specific command alone. If no other error message appears, replace U501.

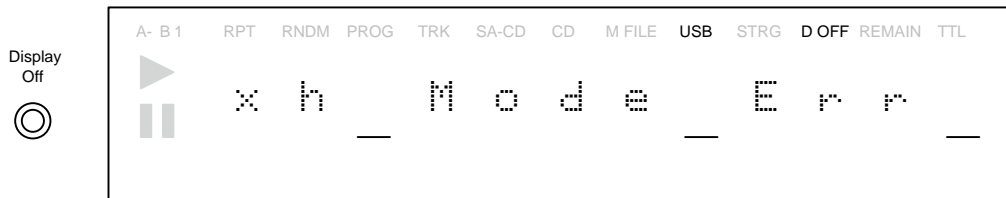

If the USB module turns off the command for setting AMS, Repeat or Random and specifying the range, the display will show the following message.

If the error persists after the mode is switched to Disc from USB and then reswitched to USB and the designated remote control code is sent, U501 may be broken as it will not accept a specific command alone. If no other error message appears, replace U501.

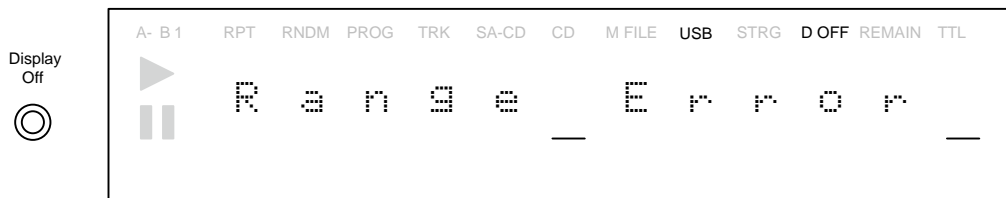

When the unit has failed to search for a folder or a file, obtain folder information or set the default, the display will show the following message.

If this error repeats, U501 may be broken. If that is the case, replace U501.

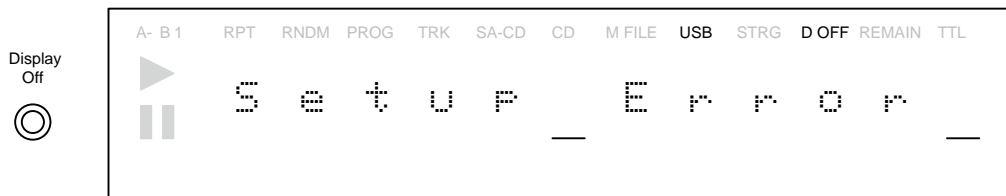

If the unit has failed to obtain information of the file to be played back, the display will show the following message. If this error occurs to a specific file, the file information may be corrupted. Check the file header and other information.

If the error occurs to all files, U501 may be broken. If no other error message appears, replace U501.

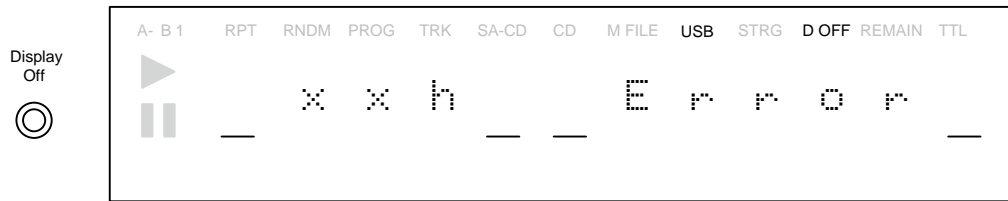

If the unit has failed to obtain information of the SB manufacturer, the product and the serial number, the display will show the following message.

On the display, the "x" will be replaced by the number 1, 2 or Failed to obtain manufacturer information; 2. Failed to obtain product information; 3. Failed to obtain serial number

If this message appears, use of the device will not be covered by the warranty.

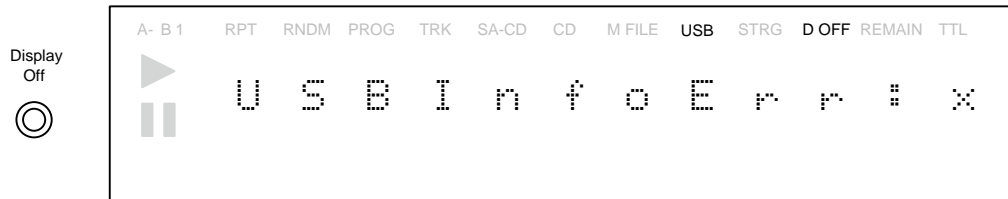

If the unit has failed to set a decodable file, the display will show the following message.

If the error persists after the mode is switched to Disc from USB and then reswitched to USB and the designated remote control code is sent, U501 may be broken as it will not accept a specific command alone. If no other error message appears, replace U501.

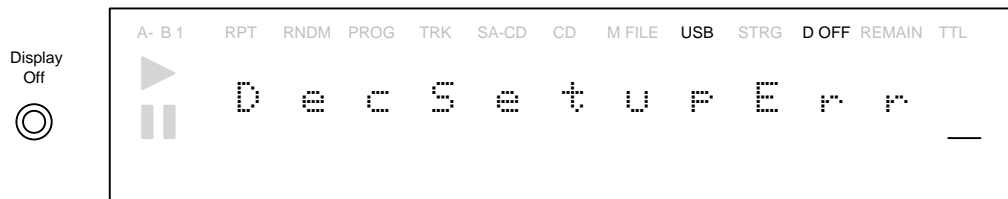



(2) Error Message that can be displayed while an iPod device is connected

If the unit experiences an error in the recognition process or fails to receive required information from an iPod device, the display will show the following message.

If this error has occurred, try unplugging and plugging the device again. If the same message is displayed again, try another iPod device.

If the unit works normally with another iPod, advise the user to repair the iPod device.

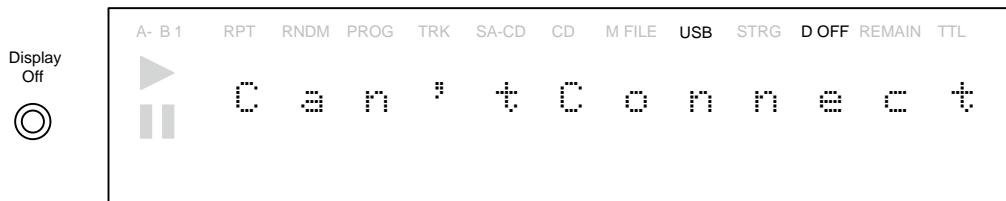

If an error occurs to communication commands in the recognition process, the display will show the following message. This message is mainly for debugging software and normally does not appear.

The display shows this message for only 3 seconds and then changes to "Can'tConnect".

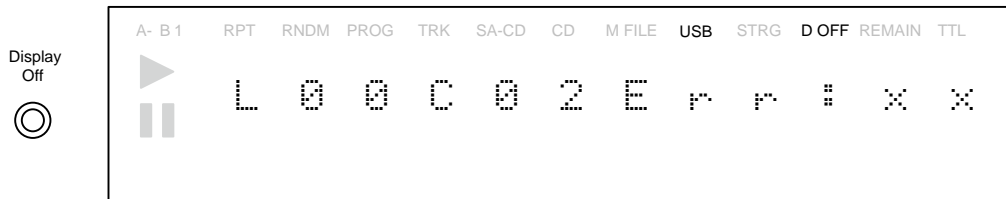

If the unit has failed to receive response from the iPod device within a given timeframe for the processing, the display will show the following message.

If no error occurs with another iPod device, advise the user to replair the iPod device.

This message is displayed for 3 seconds only and then changes to "Can'tConnect".



If the unit fails to receive response from the iPod device within a given period of time after sending a command, the display will show the following message.

If no error occurs with another iPod device, advise the user to repair the iPod device.

This message is displayed for only 3 seconds and then changes to "Can'tConnect".



If an error occurs to communication commands while the unit is performing normal operations excluding such basic ones as PLAY, PAUSE and SEARCH, the display will show the following message.

This message is mainly for debugging software and normally does not appear.

After this message is displayed, the unit automatically resets the USB module.

If the error persists after the unit is restarted, U501 may be broken as it will not accept a specific command alone.

If no other error message appears, replace U501.

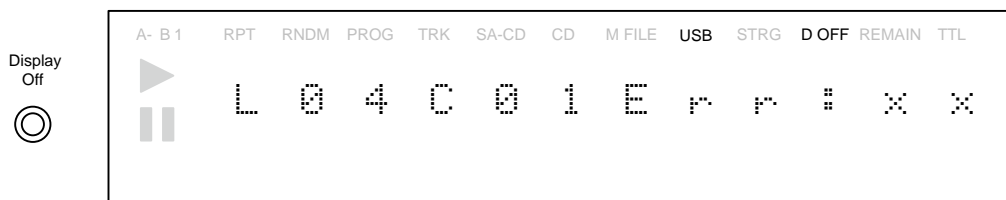

If an error occurs to communication commands while the unit is performing normal operations including PLAY, PAUSE and SEARCH, the display will show the following message. This message is mainly for debugging software and normally does not appear.

After this message is displayed, the unit automatically resets the USB module.

If the error persists after the unit is restarted, U501 may be broken as it will not accept a specific command alone.

If no other error message appears, replace U501.

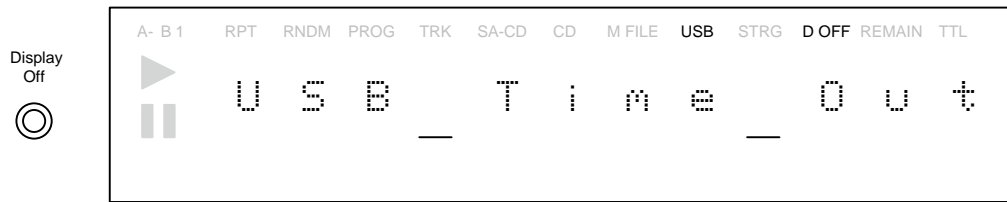

If an error occurs to the command communication to indicate a change in the sampling frequency, the display will show the following message.

This message is mainly for debugging software and normally does not appear.

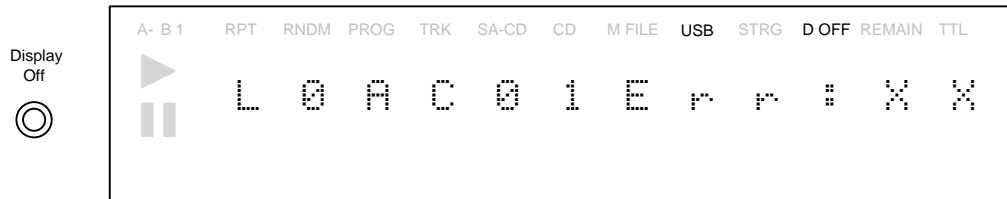

Upon confirming that an iPod device is connected, the unit will begin modifying the USB communication method. If an error occurs in this process, the display will show the following message.

If this message reappears after unplugging and plugging the iPod device, U501 may be broken as it will not accept a specific command alone.

If no other error message appears, replace U501.

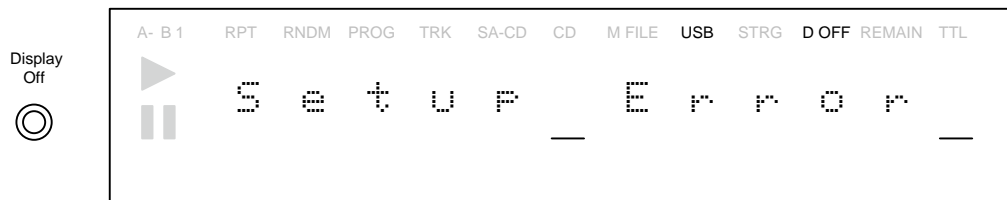

## VERSION UPGRADE PROCEDURE OF FIRMWARE

### ABOUT REPLACE THE MICROPROCESSOR WITH A NEW ONE

When replaced of the U-PRO (Microprocessor), confirm contents of the following.

PWB Name	Ref. No.	Description	After replaced	Remark
8U-210103-1	U102	R5F212CCSNFP	C	

After replaced

- A** : Mask ROM (With software). No need write-in of software to the microprocessor.
- B** : Flash ROM (With software). Usually, no need write-in of software. But, when the software was updated, you should be write-in of the new software to the microprocessor or flash ROM. Please check the software version.
- C** : Empty Flash ROM (Without software). You should be write-in of the software to the microprocessor. Refer to "Update procedure" or "writing procedure", when you should be write-in the software.

#### [A]Update Front CPU's software to internal Flash-ROM.

- This mode is to update the software for microprocessor.
- The target device is internal flash ROM of microprocessor (U102) on 8U-210103-1.
- The updating of software takes about 1 minute.

#### Necessary Equipment

- Windows PC (OS: Windows 2000 or Windows XP) with Serial port.
- RS-232C Dsub-9 pin cable (female to female/straight type).
- Update software to CPU. (FlashSta.exe, SACD\_yymmddvv.mot and SACD\_yymmddvv.id in Front CPU (SA8004) folder)
- DATA UPDATE KIT (part no. 90M-SR4001JIG)

Use DATA UPDATE KIT to connect PC and N941 (FFC connector) in rear panel of the unit.

#### Update Software for Front CPU

- (1) Put the "Front CPU (SA8004)" folder into anywhere on your PC's hard disc.

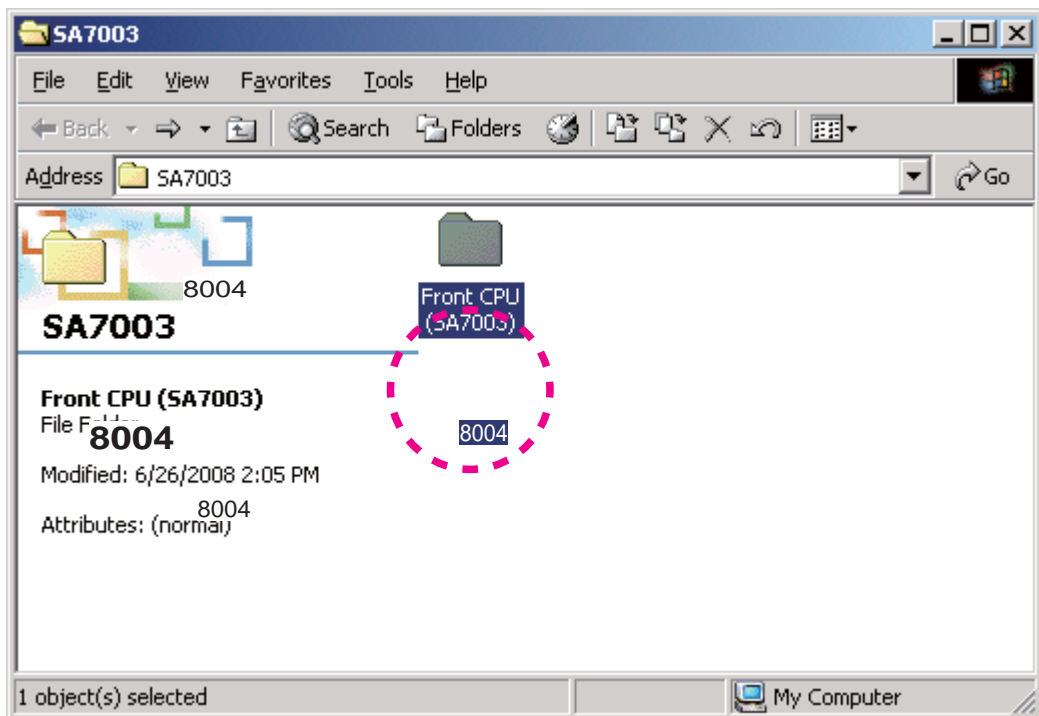

- (2) Connect PC and DATA UPDATE KIT with the RS-232C cable.

(3) Connect FPC (upside contact) to the rear panel of the unit from DATA UPDATE KIT

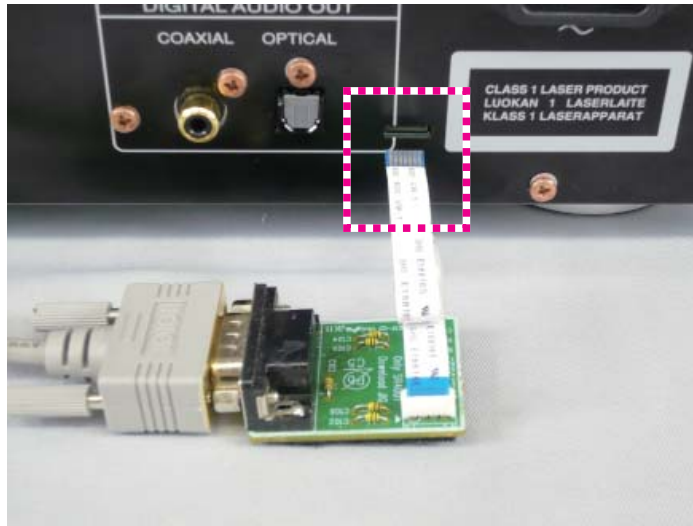

(4) Connect the mains cord into the unit.

(5) Double click the FlashSta.exe. And launch the M16 Flash Start.

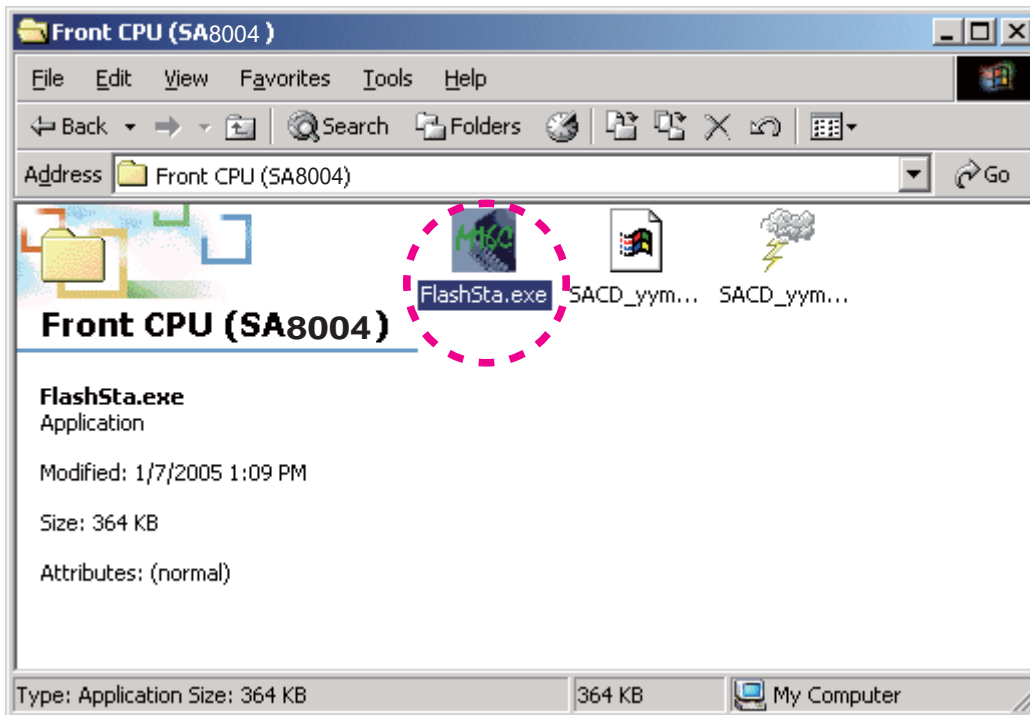

- (6) Check the Internal flash memory in the Select Program.  
Choose the COM Port number.  
And click the OK.

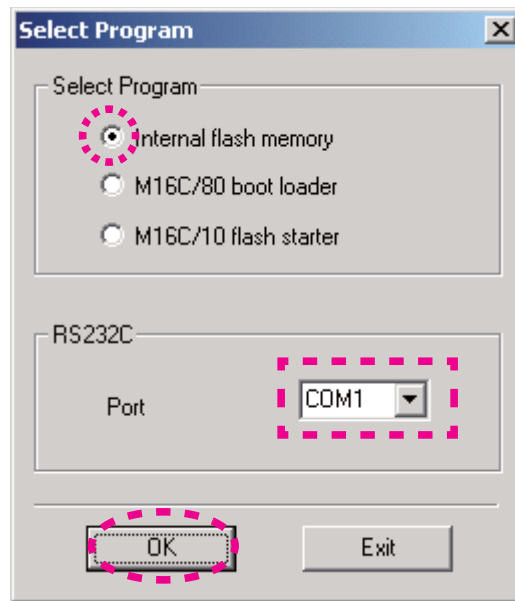

- (7) Click the Refer....

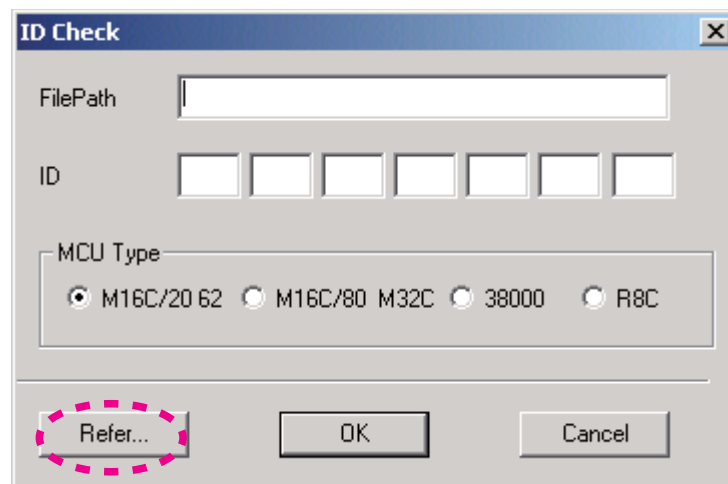

- (8) Choose the SACD\_yymmdd.mot. And click the Open.  
**NOTE** : The yy is two digits of year. The mm is month. The dd is date.

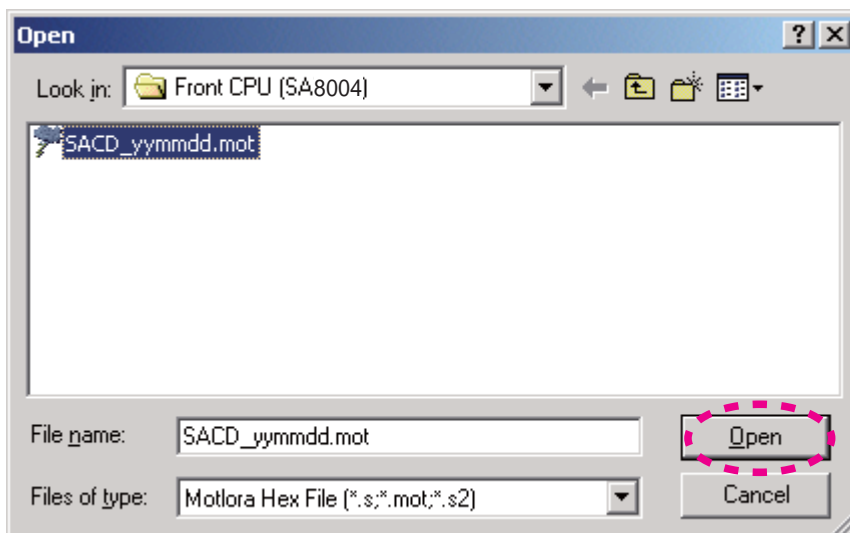

- (9) The FilePath and ID are inputted automatically, and the MCU Type is selected to R8C automatically. Click the OK.

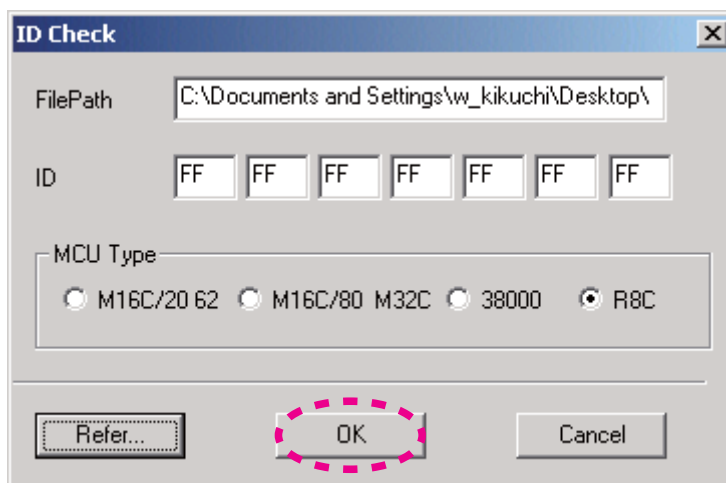

(10) Click the E.P.R....

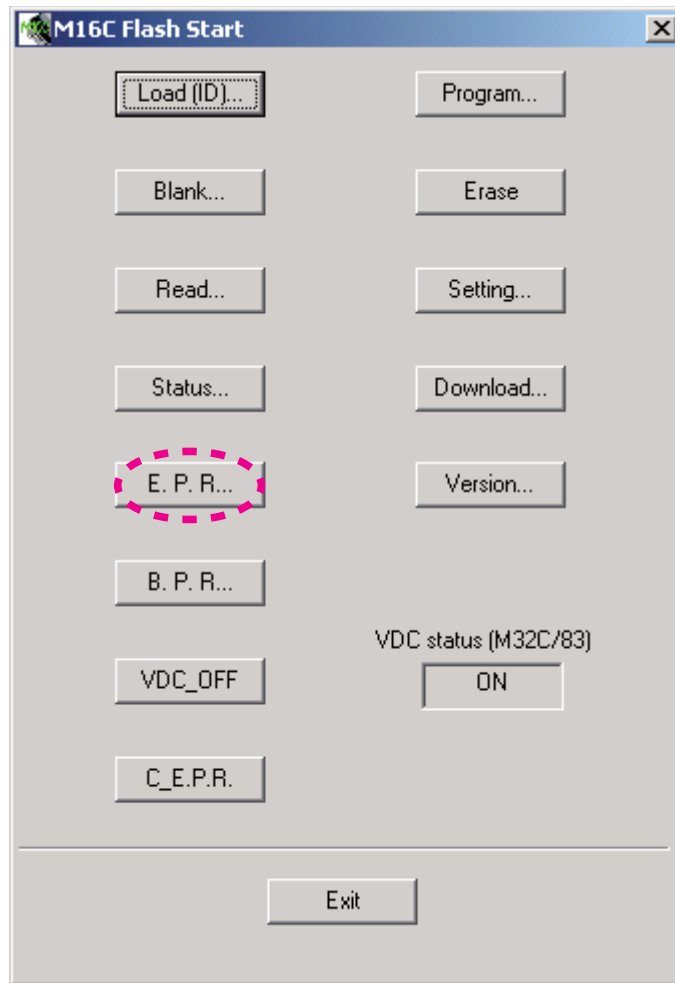

(11) Click the OK.

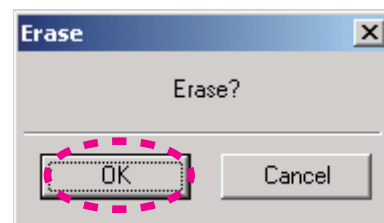

- (12) Software is written into the internal Flash-ROM of Front CPU.  
The writing of software takes about 1 minute.

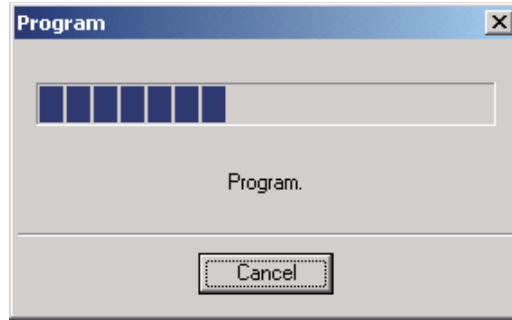

- (13) Click the OK.



- (14) Click the Exit.

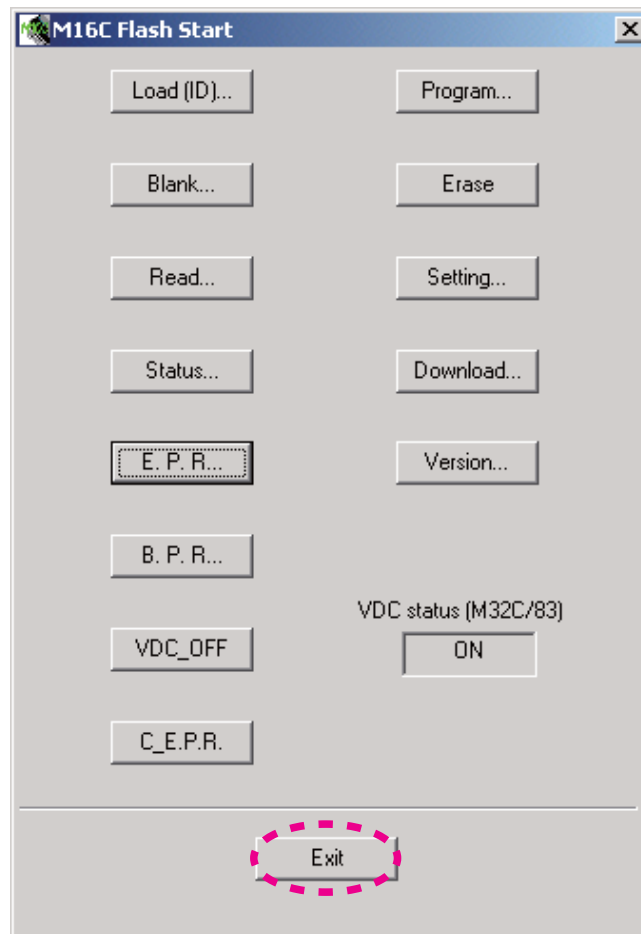

- (15) Disconnect the mains cord.  
(16) Disconnect the FFC of DATA UPDATE KIT from the unit.



## [B]UPDATE FIRMWARE FOR Super Audio CD MODULE

### Necessary Equipment

- Update Disc (90M-SA7003CDR)

### WRITING PROCEDURE

- (1) Connect the mains cord into the unit.
- (2) Turn on the unit.
- (3) Press the ▲ button to open the tray.
- (4) Insert the Update Disc.
- (5) Press the ▲ button to close the tray.
- (6) "Upgrade?" is displayed on the front display. Then Press ► button.
- (7) Remove the update disc from the tray, when the tray is opened automatically. At that time "Upgrade" is blinking on the front display.
- (8) When update succeeded, the tray is closed automatically.
- (9) And "No Disc" is displayed on the front display.
- (10) Turn off the unit.
- (11) Disconnect the mains cord from the unit.

# TROUBLE SHOOTING

※ Please refer to "MEASURING METHOD AND WAVEFORMS" for details in a waveform.

## 8U-210103-1(DIGITAL POWER UNIT)

Check the DIGITAL power supply component

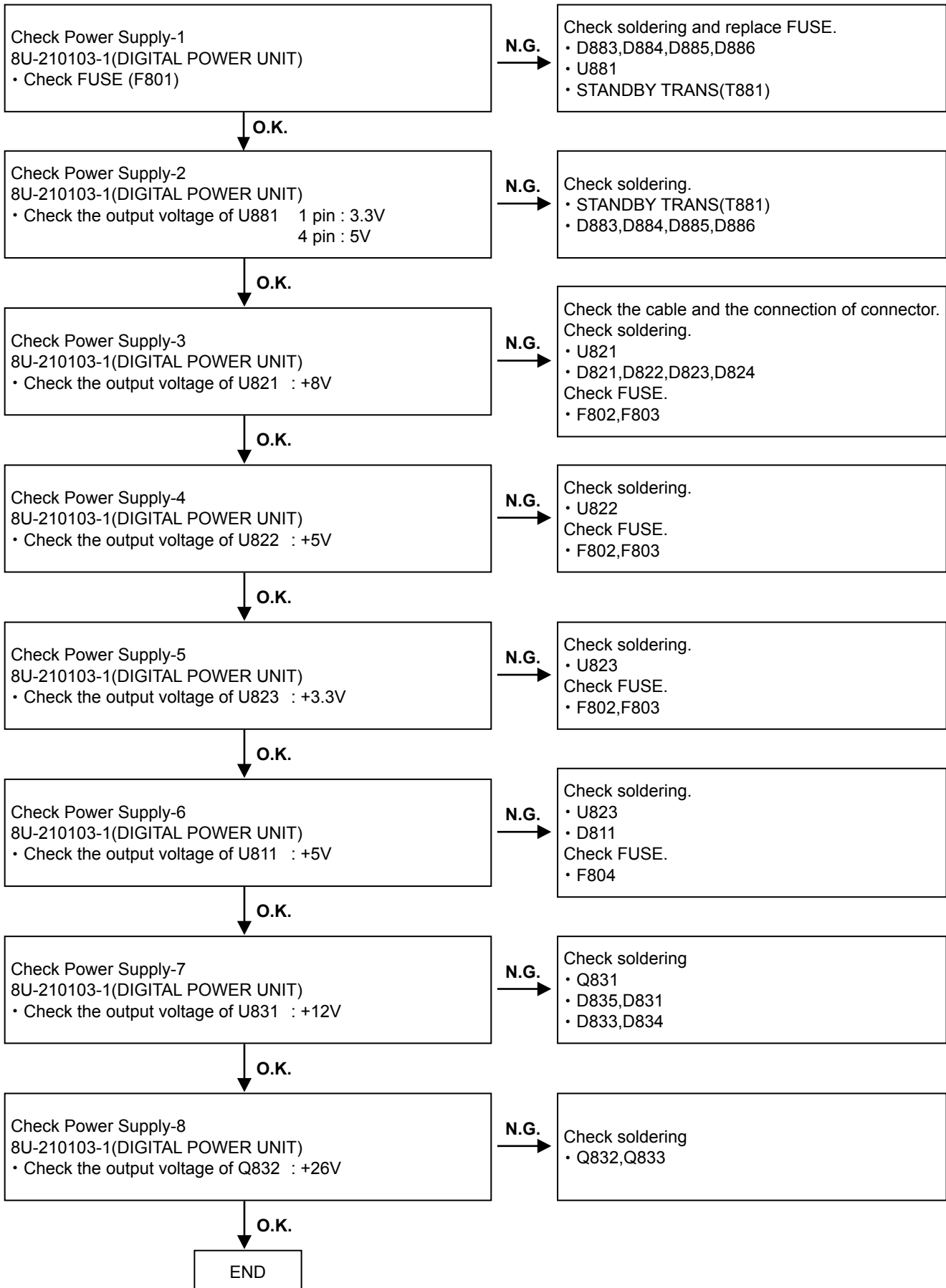

**00MZK35AK0020(SACD MODULE UNIT)**

**Check the voltage of SACD module**

Check Power Supply-1  
8U- 210103-1

- Check the output voltage of N103 29 pin : +12V
- Check the output voltage of N103 28 pin : +8V
- Check the output voltage of N103 27 pin : +8V
- Check the output voltage of N103 26 pin : +8V
- Check the output voltage of N103 25 pin : +8V

N.G.

Check the cable and the connection of connector.  
Check soldering.

- N103
- U831,U821,L822,L823

O.K.

Check the connection between SACD module and microprocessor  
8U- 210103-1

- N103 11pin ACK
- N103 12pin MDATA
- N103 13pin SDATA
- N103 14pin SCLK
- N103 15pin XREDY
- N103 16pin XDVRST
- N103 17pin POWER

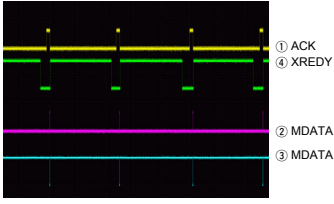

① ACK  
④ XREDY  
② MDATA  
③ MDATA

N.G.

Check the cable and the connection of connector.  
Check soldering.

- N103
- U102,U103,L113,L114,L115,L116,L117,L118

O.K.

END

**8U-110090-1(FRONT UNIT)**

Check Power Supply-1  
8U- 110090-1

- Check the output voltage of N701 2 pin : +3.3V
- Check the output voltage of N701 3 pin : +5V
- Check the output voltage of N701 5 pin : +26V
- Check the output voltage of N701 13 pin : +5V
- Check the output voltage of N701 14 pin : +3.3V

N.G.

Check the cable and the connection of connector.  
Check soldering.

- N701 (8U-110090-1)
- N104 (8U-210103-1)
- U881 (8U-210103-1)
- U822 (8U-210103-1)

O.K.

Check connection between Display and microprocessor-1  
8U-110090-1

- Z701 35pin DATA
- Z701 36pin CLOCK
- Z701 37pin CHIP SELECT
- Z701 38pin RESET

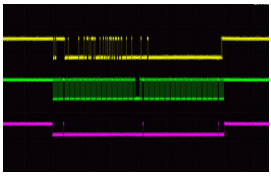

② DIS\_SO  
② DIS\_SCL  
② DIS\_CS

N.G.

Check the cable and the connection of connector.  
Check soldering.

- Z701 (8U-110090-1)
- N701 (8U-110090-1)

O.K.

Check the remote control signal-1  
8U- 210103-1

- Z702 3pin 5V
- Z702 1pin Remote control signal

N.G.

Check soldering.

- Z702 (8U-110090-1)

O.K.

END

## 8U-210103-2(AUDIO UNIT)

Check AUDIO UNIT

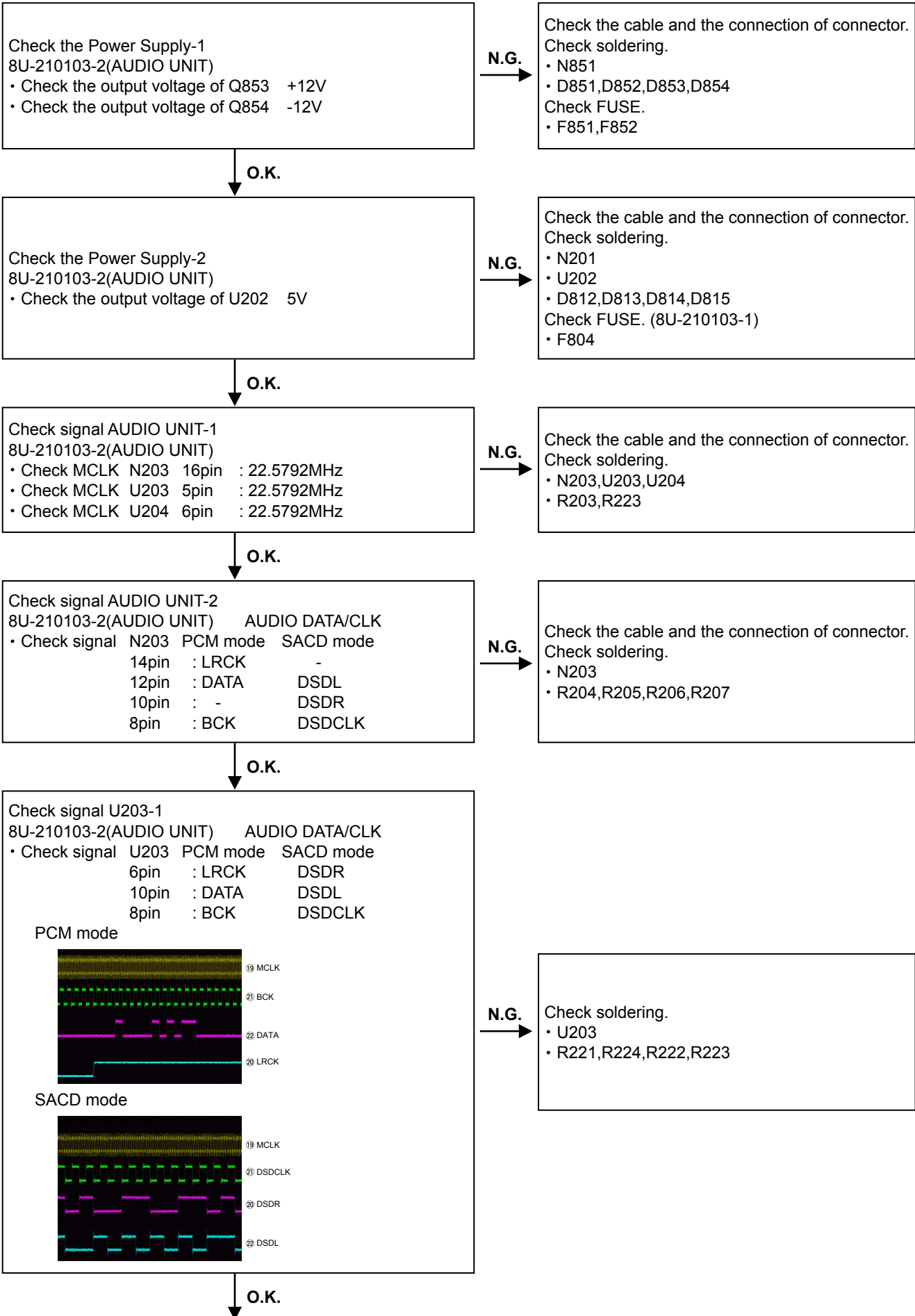

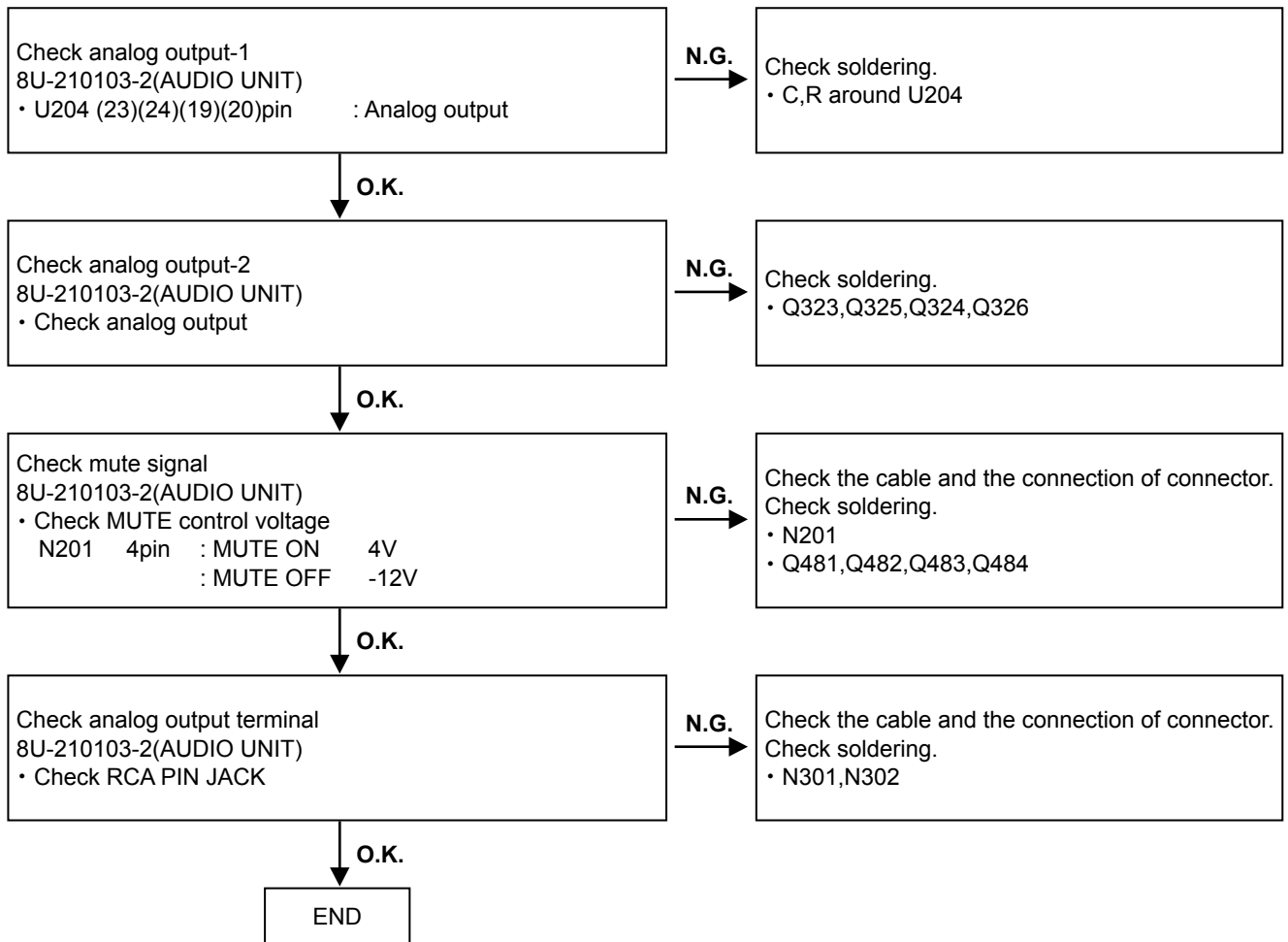

**8U-210103-3(DIR,USB\_DAC UNIT)**

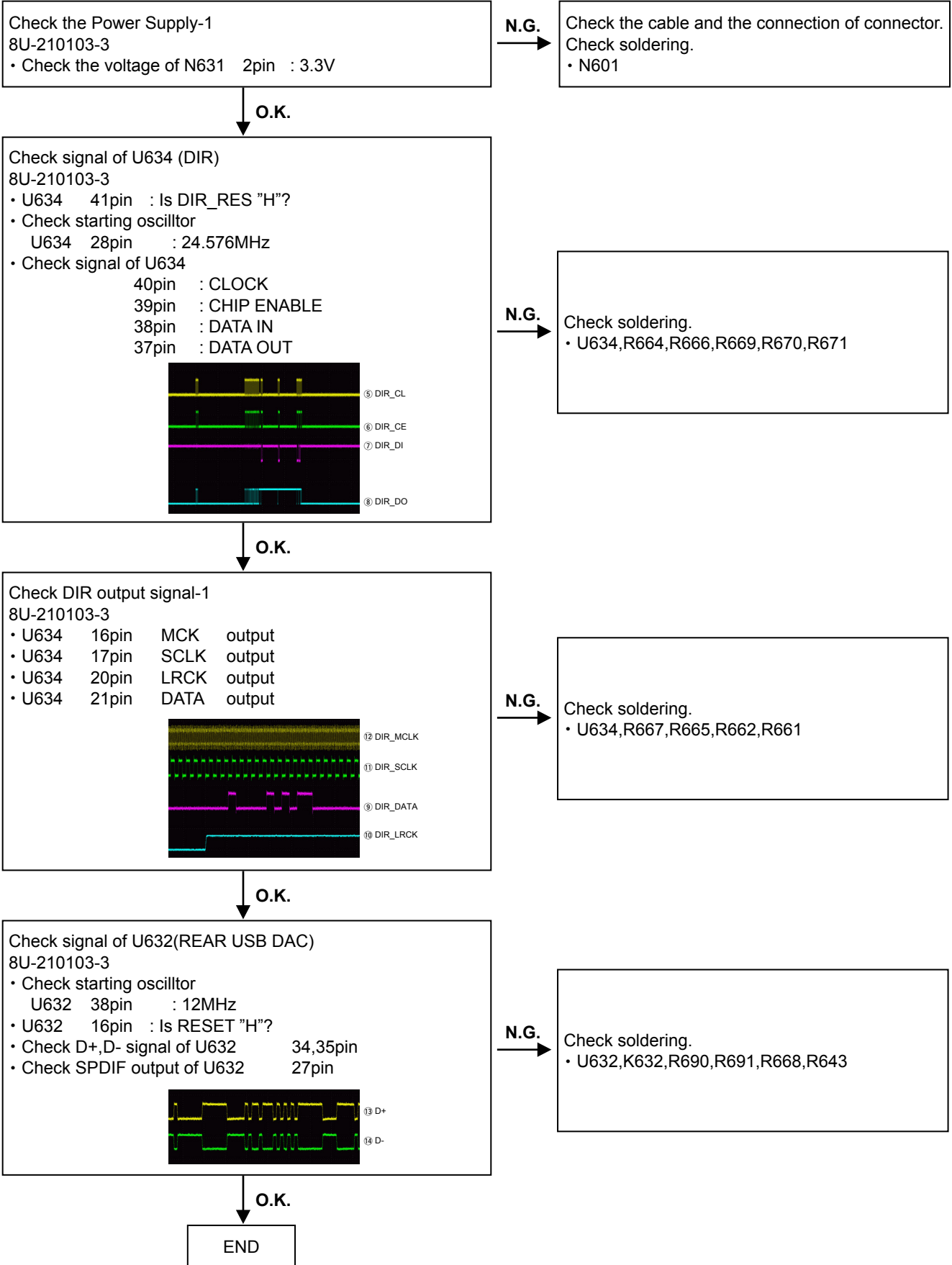

## 8U-210103-1(USB\_iPod)

Check power supply  
8U-210103-1  
• Check voltage of U501  
(6)(13)(48)(53)(62)(96)(116)(128)(143)pin : 3.3V

N.G.

Check the cable and the connection of connector.  
Check soldering.

- U811 (8U-210103-1)
- N104 (8U-210103-1)
- U701 (8U-110090-1)
- N701 (8U-110090-1)

O.K.

Check signal of U501 (FRONT USB/iPod)  
8U-210103-1

- U501 19pin : Is USB\_RES "H"?
- Check starting oscilltor.  
U501 50pin : 16.9344MHz
- Check starting oscilltor.  
U501 1pin : 48MHz
- Check signal of U501.

19pin : RTS  
34pin : CTS  
37pin : SO  
38pin : SI

- Check SPDIF output of U501 70pin



- Check D+,D- signal of U501 4,5pin

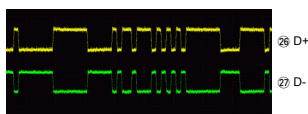

N.G.

Check soldering.

- U501
- R510,L101,L102,L103,L104,L105,L106,L107,L108,R103,R104,R503

O.K.

END

# MEASURING METHOD AND WAVEFORMS

To check the waveforms on the Main P.W.B., the GND (-) probe of the oscilloscope to “Vref” point. (Except for Inner SW, TRVSW)

Measuring Disc: SACD/DAC Test Disc  
CD/TCD-784

(It is better to use wires for extending between the probe and test points.)

- When watching the HF waveform, use the extending wire as short as possible.
- When HF waveform is noisy or cannot discriminate the eye-pattern, replace the Traverse Unit after measuring the top.
- Point ① ~ ⑳ is measured with the point shown below.

## TEST POINT

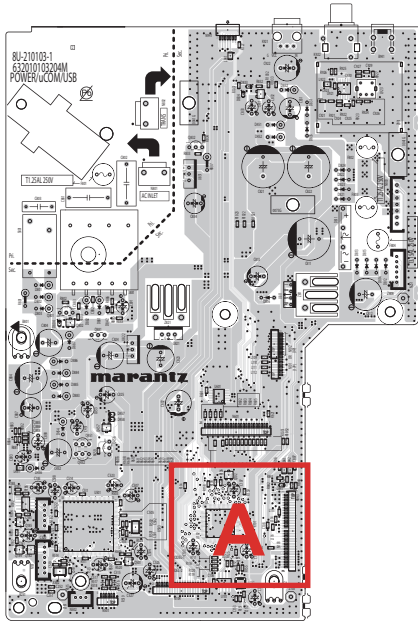

POWER/uCOM/USB UNIT (component side)

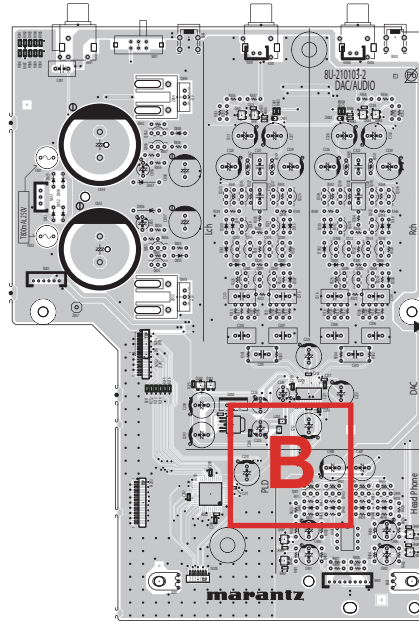

DAC/AUDIO UNIT (component side)

### Detail A

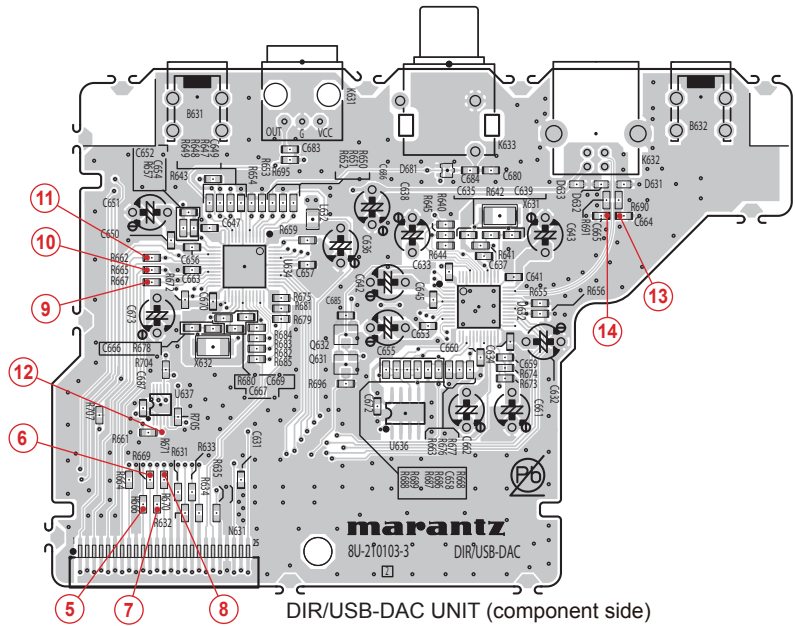
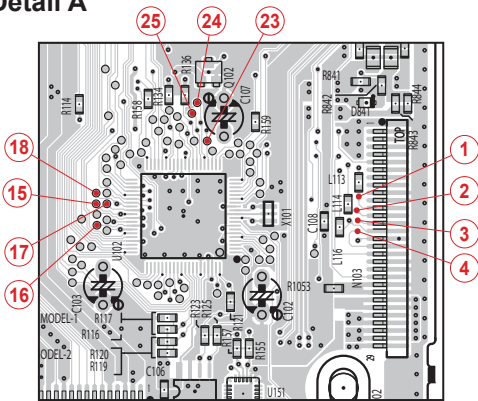

### Detail B

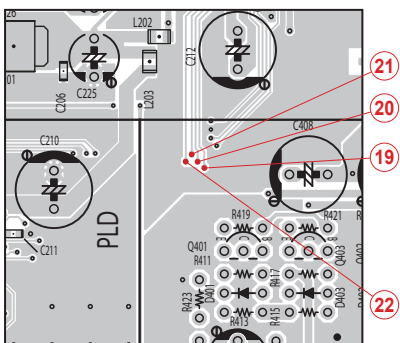

DIR/USB-DAC UNIT (component side)



# WAVEFORMS

## SACD MODULE UNIT

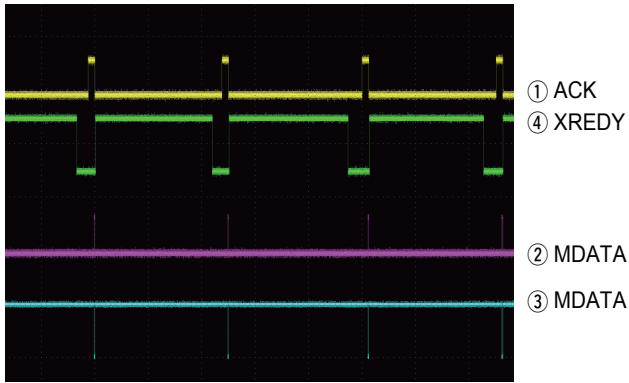

## DIR, USB\_DAC UNIT

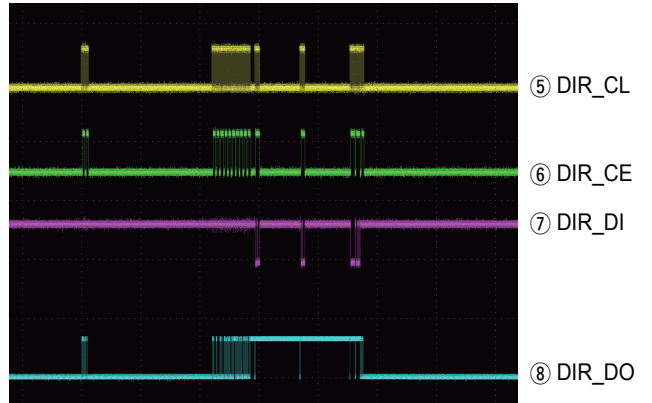

## FRONT UNIT

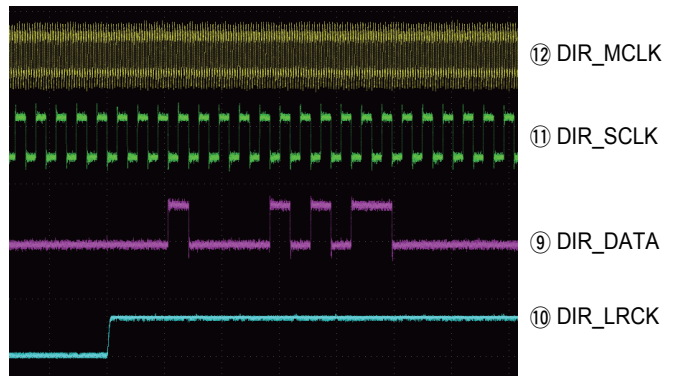
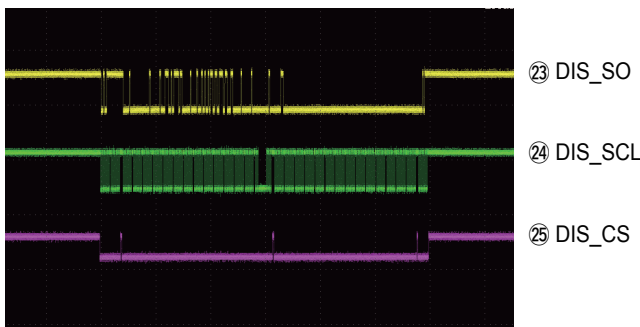

## AUDIO UNIT

PCM mode

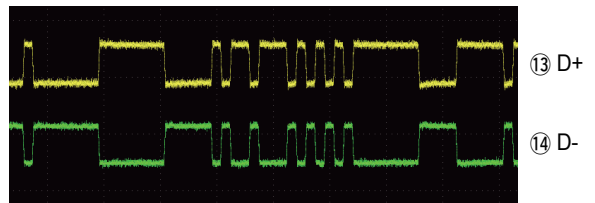
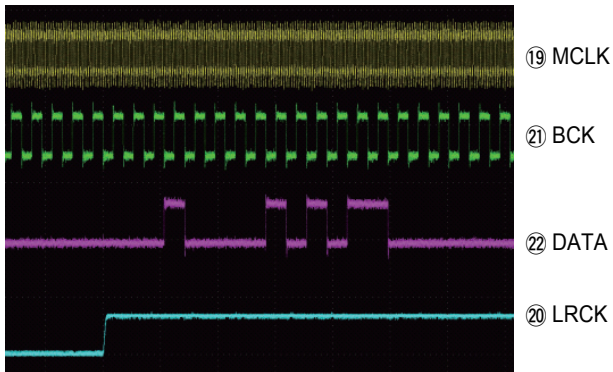

SACD mode

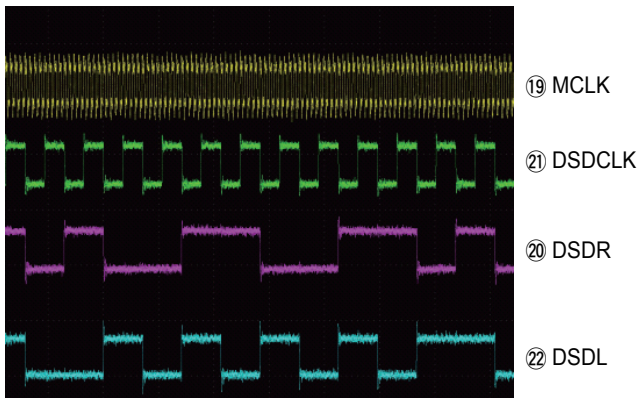

## USB\_iPod UNIT

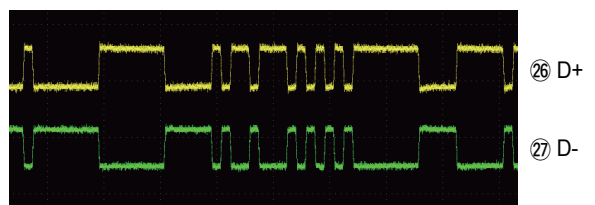
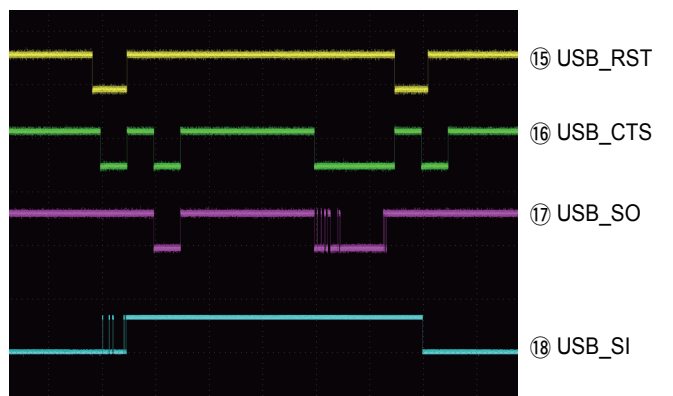



# BLOCK DIAGRAM

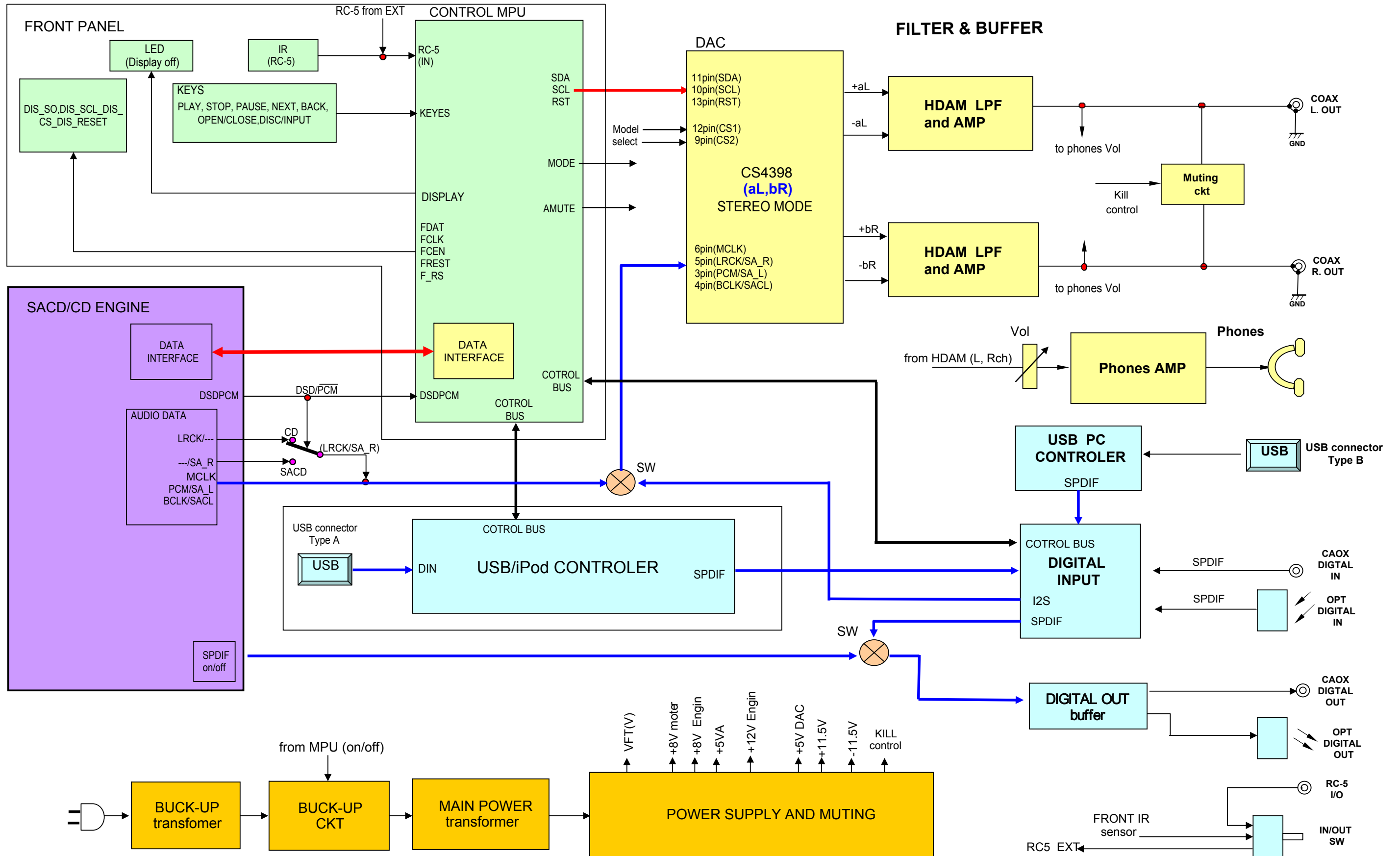

# WIRING DIAGRAM

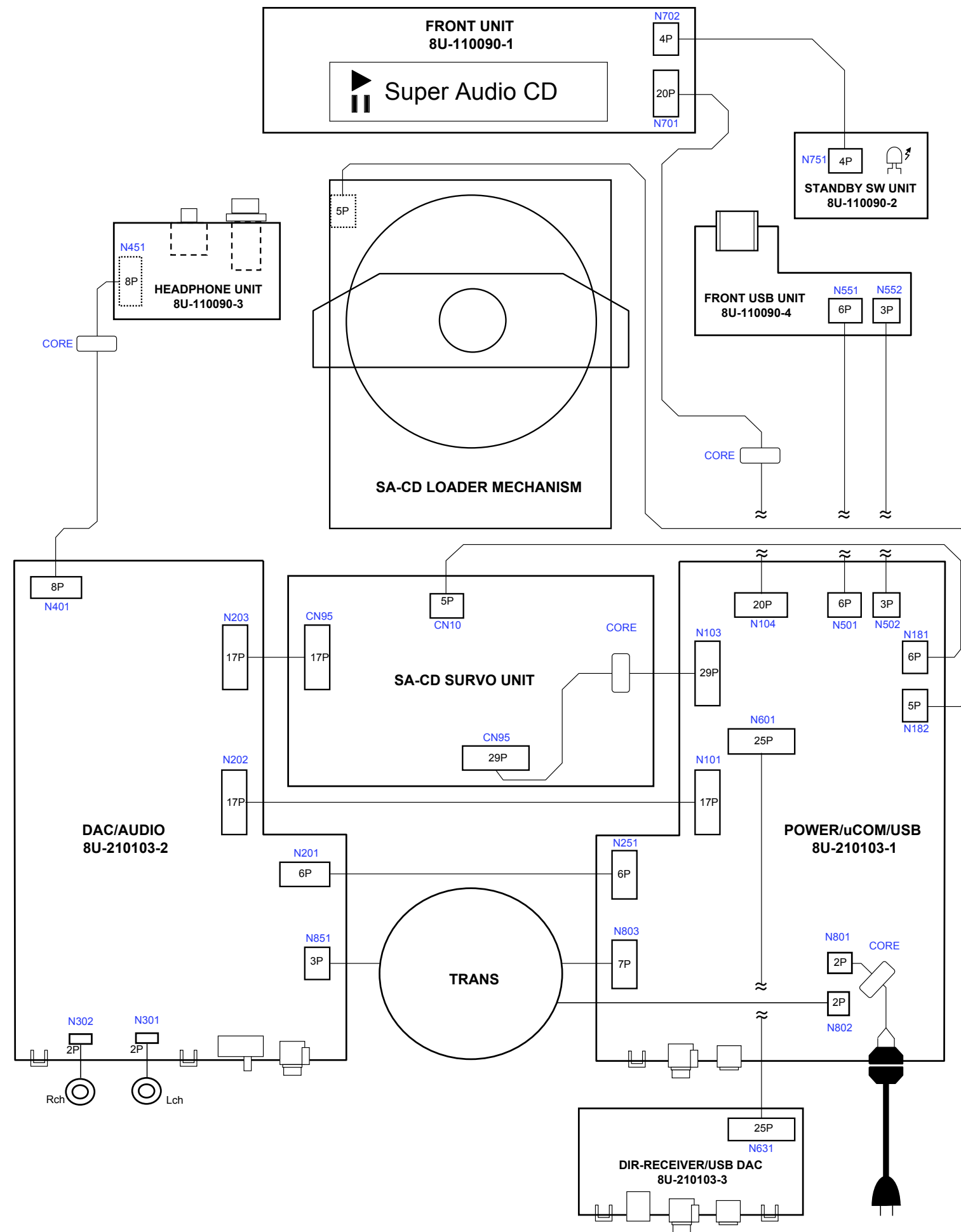

# PRINTED WIRING BOARDS

FRONT (COMPONENT SIDE)

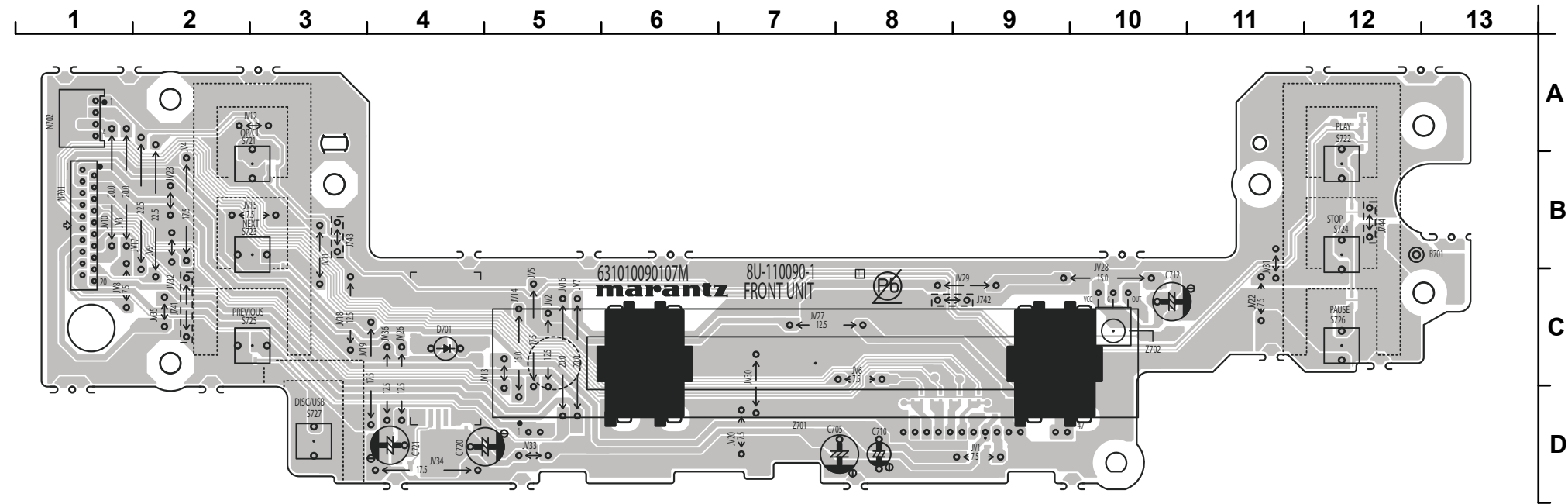

FRONT (FOIL SIDE)

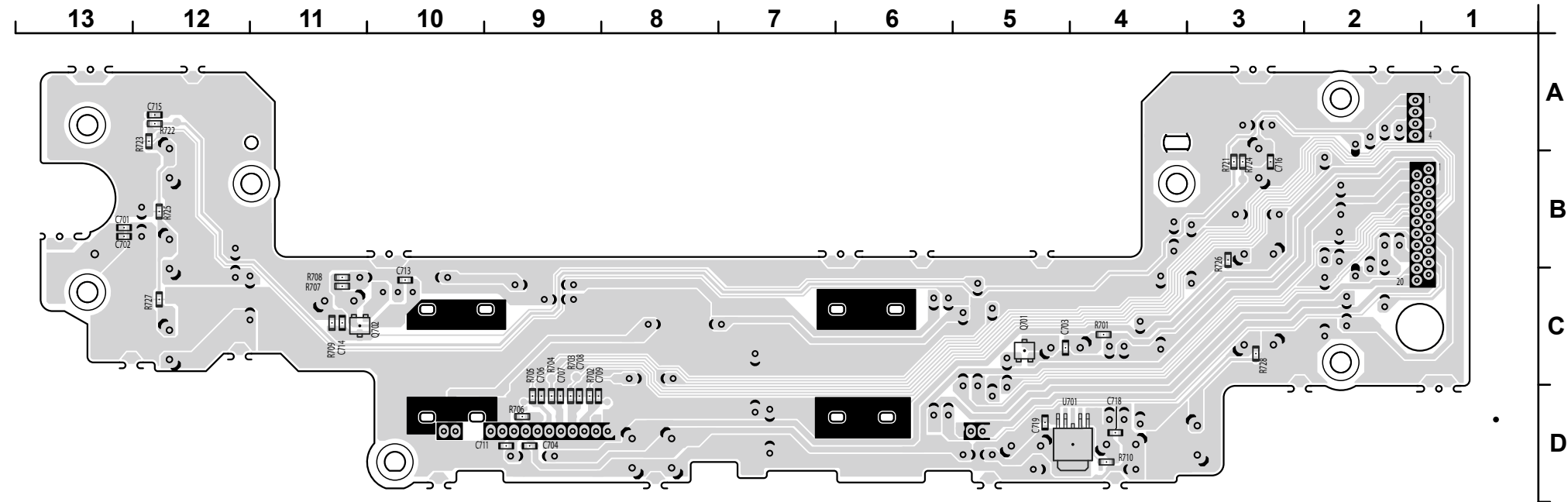

**鉛フリー半田**  
半田付けには、鉛フリー半田 (Sn-Ag-Cu) を使用してください。

**Lead-free Solder**  
When soldering, use the Lead-free Solder (Sn-Ag-Cu).

HEAD PHONE (COMPONENT SIDE)

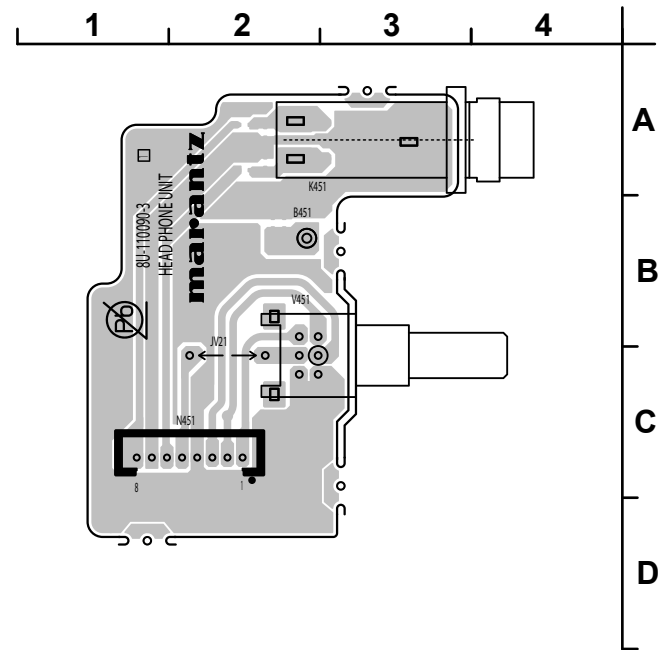

POWER SW (COMPONENT SIDE)

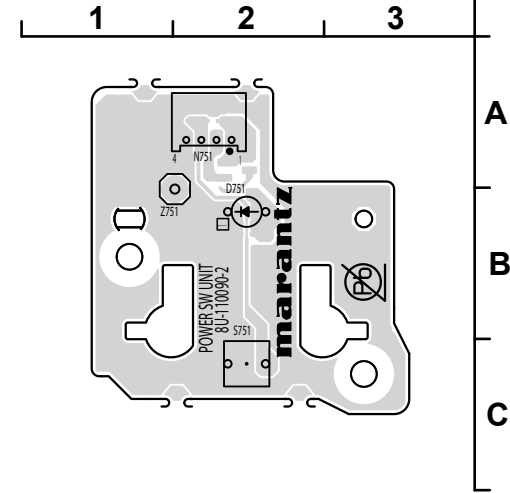

FRONT USB (COMPONENT SIDE)

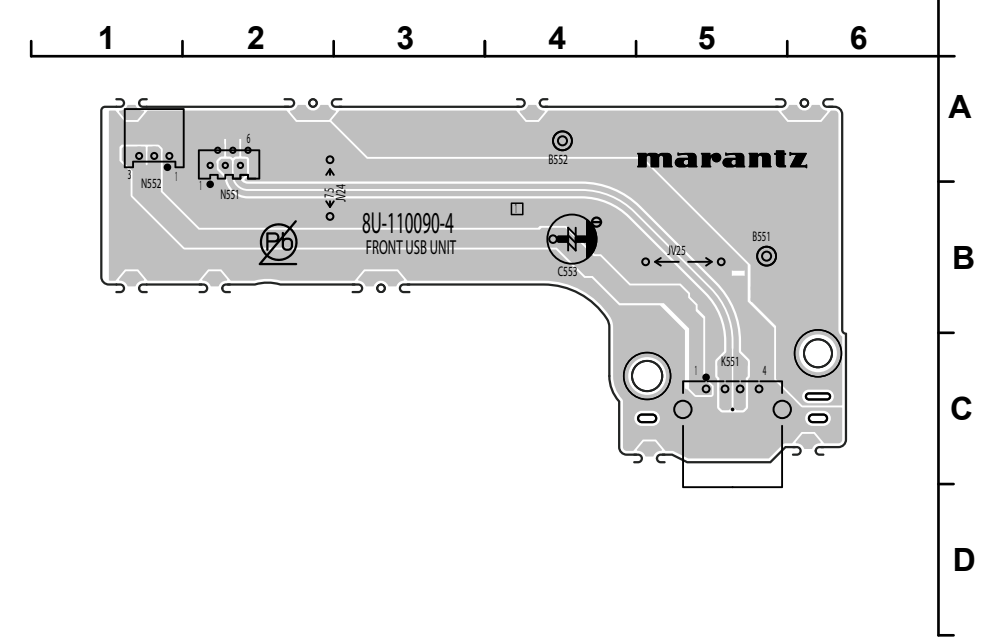

HEAD PHONE (FOIL SIDE)

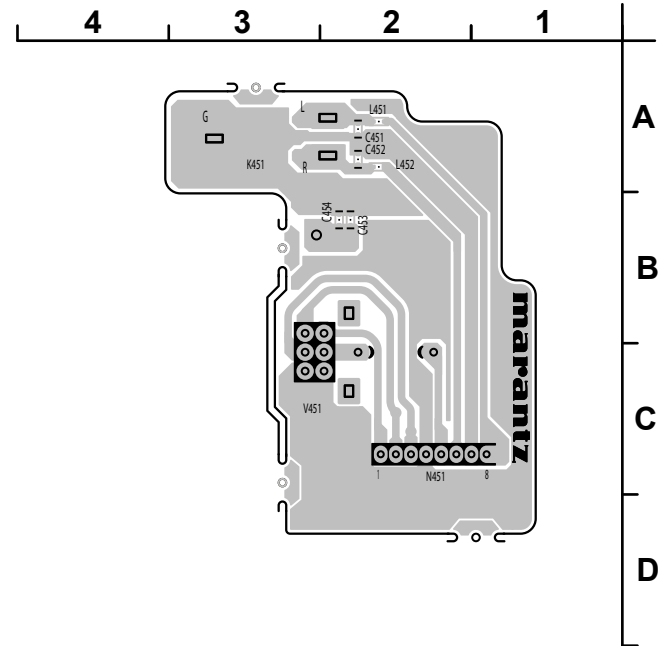

POWER SW (FOIL SIDE)

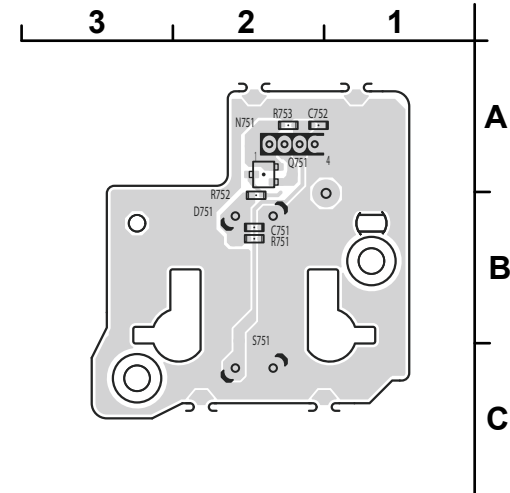

FRONT USB (FOIL SIDE)

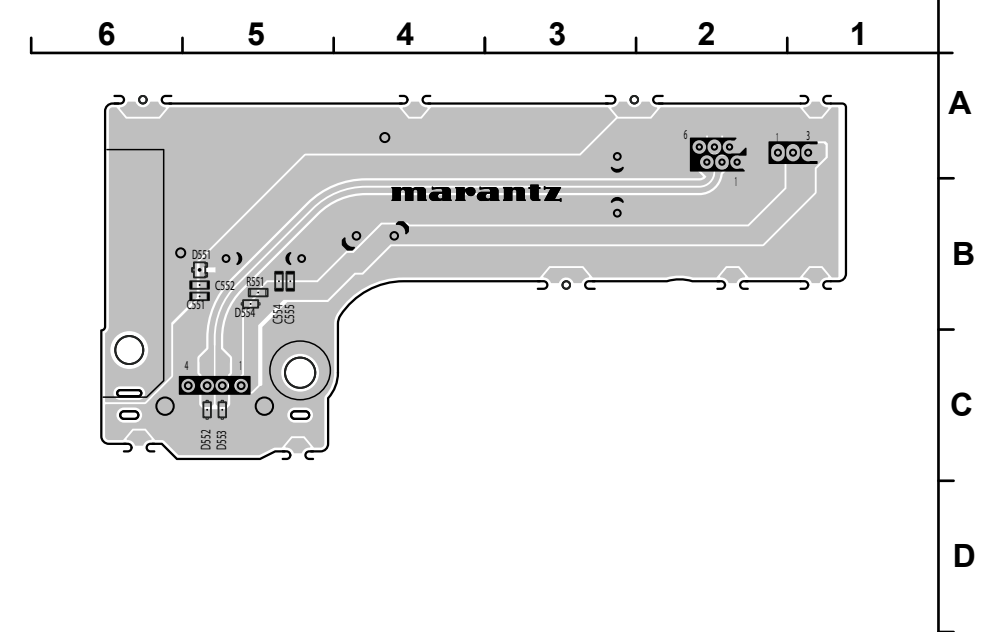

**鉛フリー半田**  
半田付けには、鉛フリー半田 (Sn-Ag-Cu) を使用してください。

**Lead-free Solder**  
When soldering, use the Lead-free Solder (Sn-Ag-Cu).

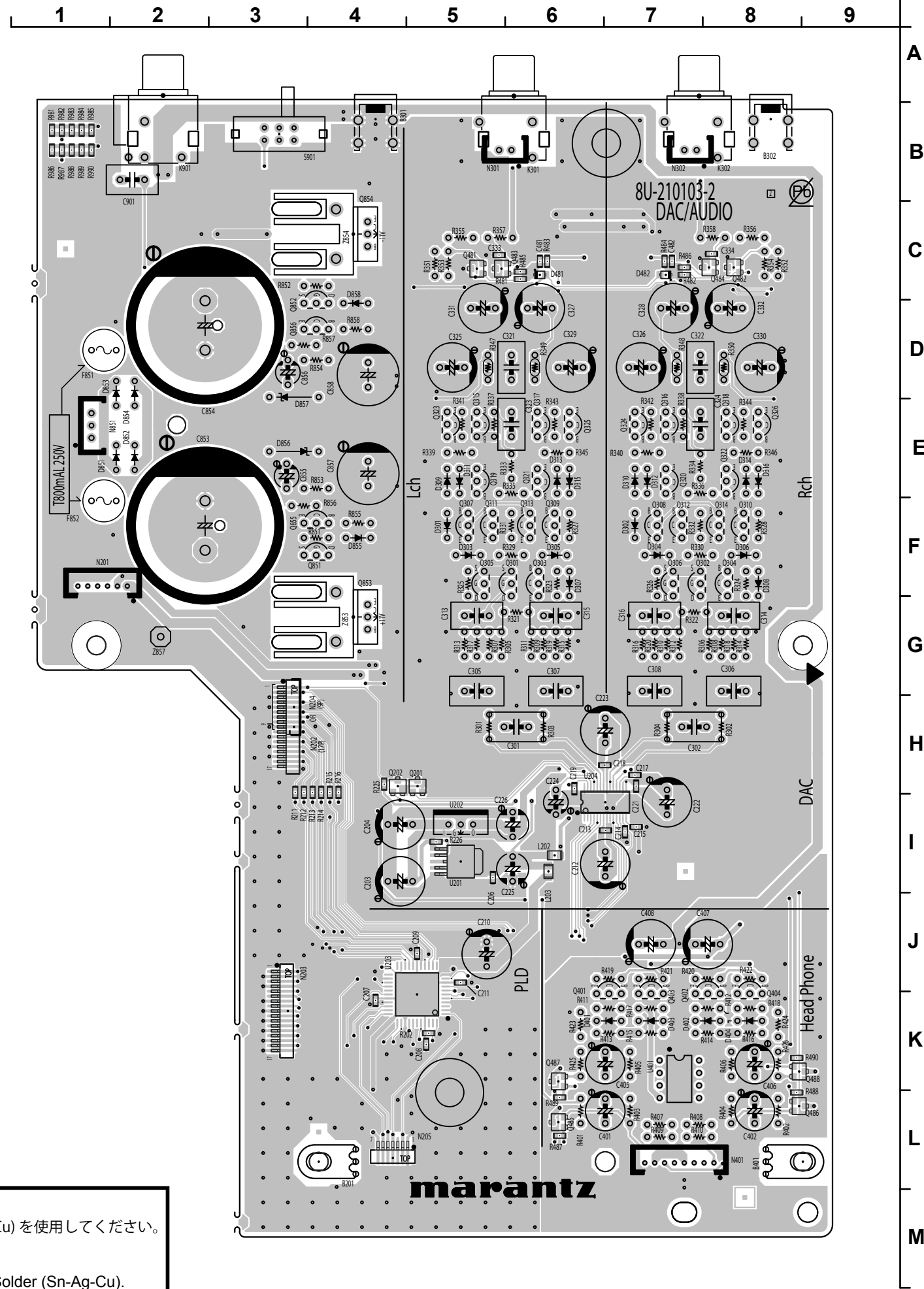

**鉛フリー半田**  
半田付けには、鉛フリー半田 (Sn-Ag-Cu) を使用してください。

**Lead-free Solder**  
When soldering, use the Lead-free Solder (Sn-Ag-Cu).

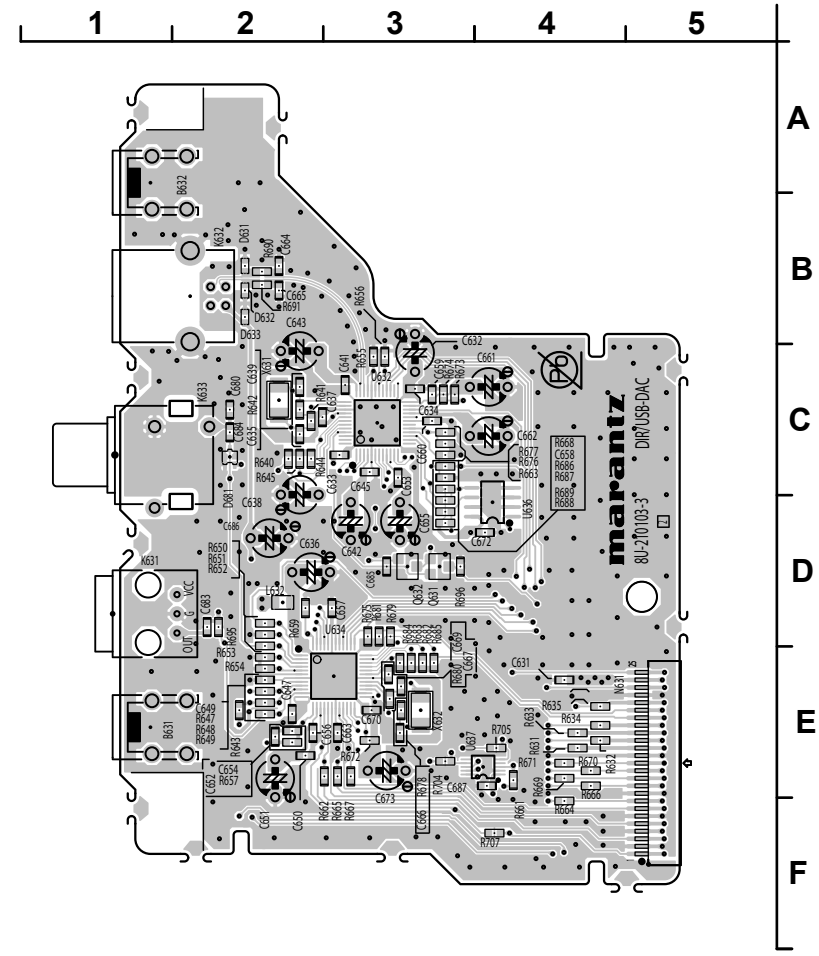



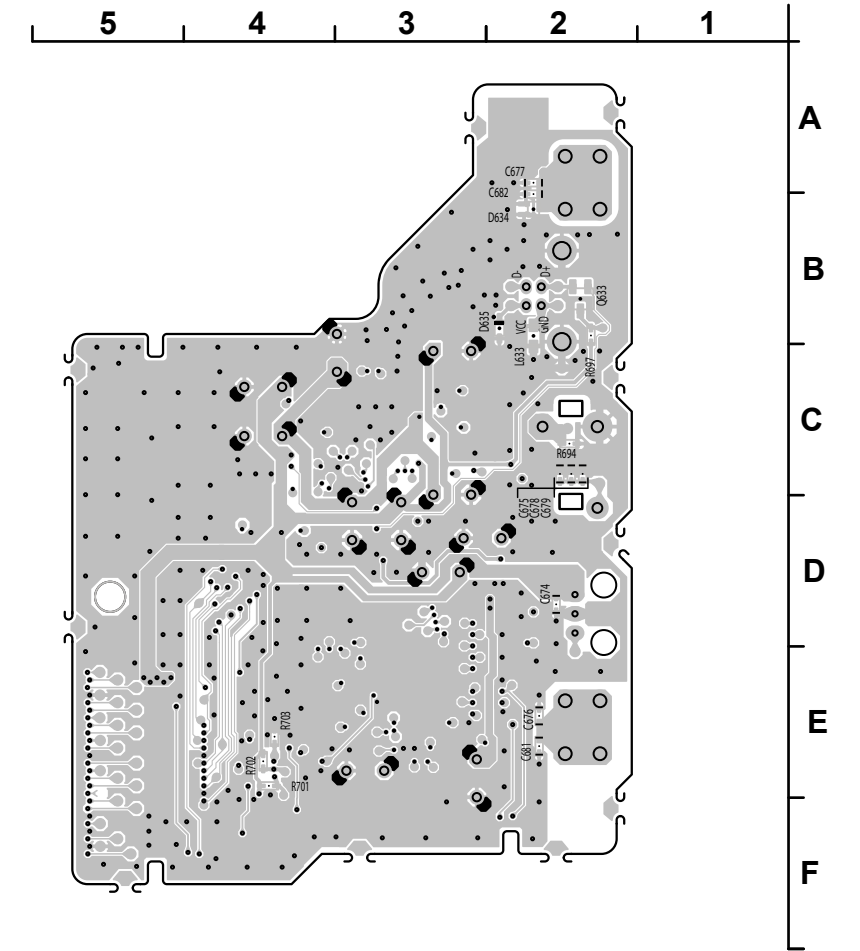
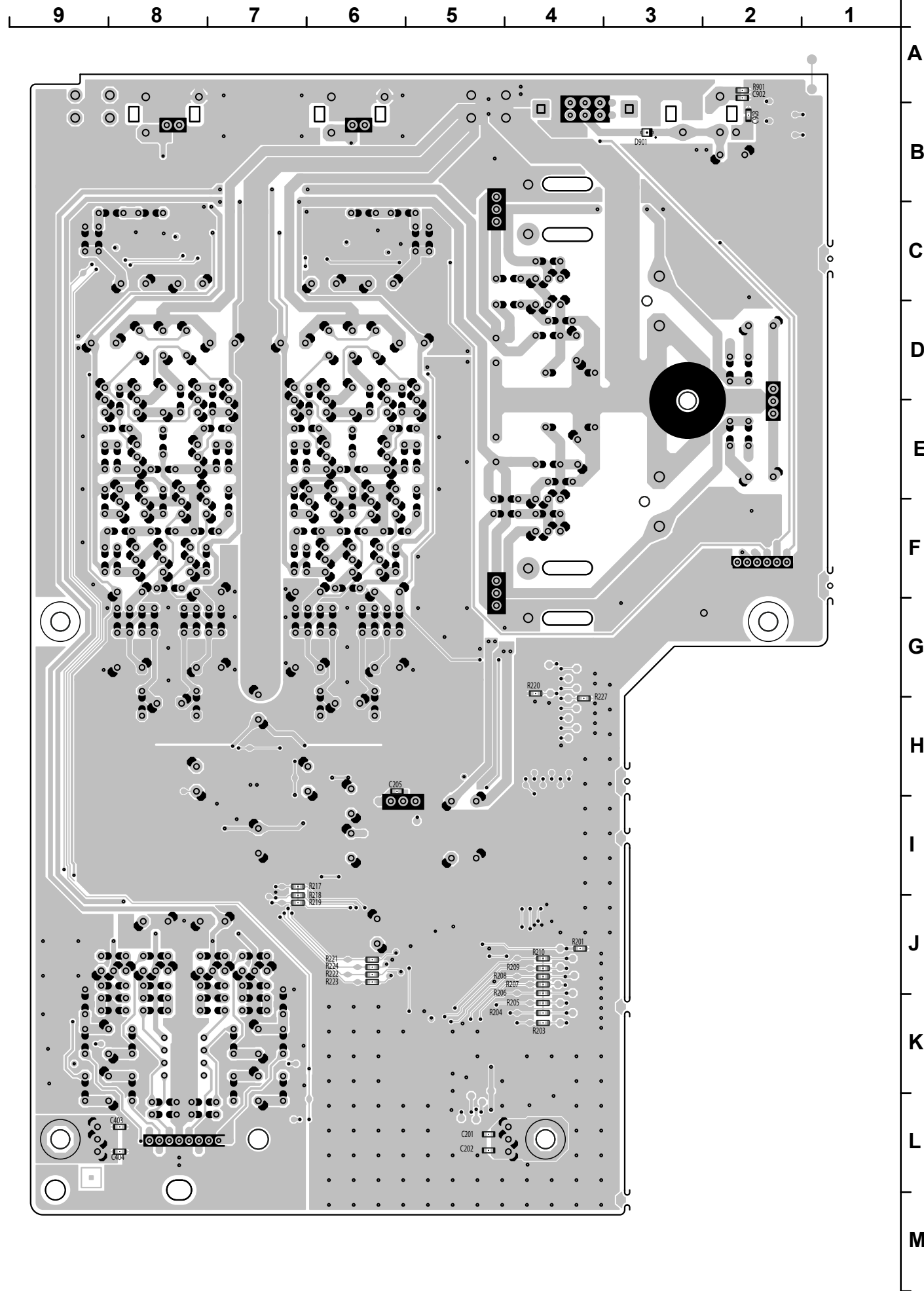

**鉛フリー半田**  
半田付けには、鉛フリー半田 (Sn-Ag-Cu) を使用してください。

**Lead-free Solder**  
When soldering, use the Lead-free Solder (Sn-Ag-Cu).



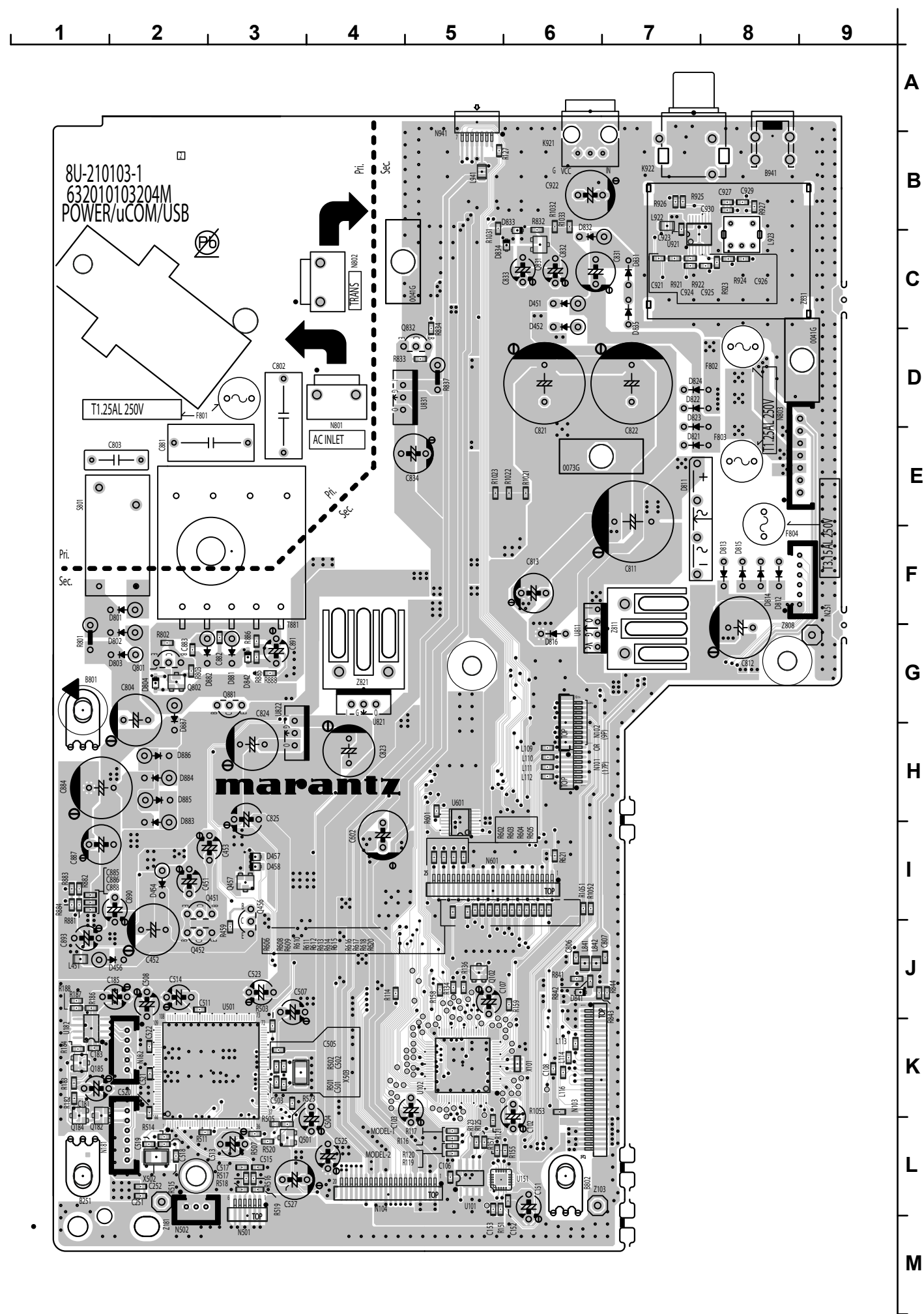

**鉛フリー半田**  
 半田付けには、鉛フリー半田 (Sn-Ag-Cu) を使用してください。

**Lead-free Solder**  
 When soldering, use the Lead-free Solder (Sn-Ag-Cu).

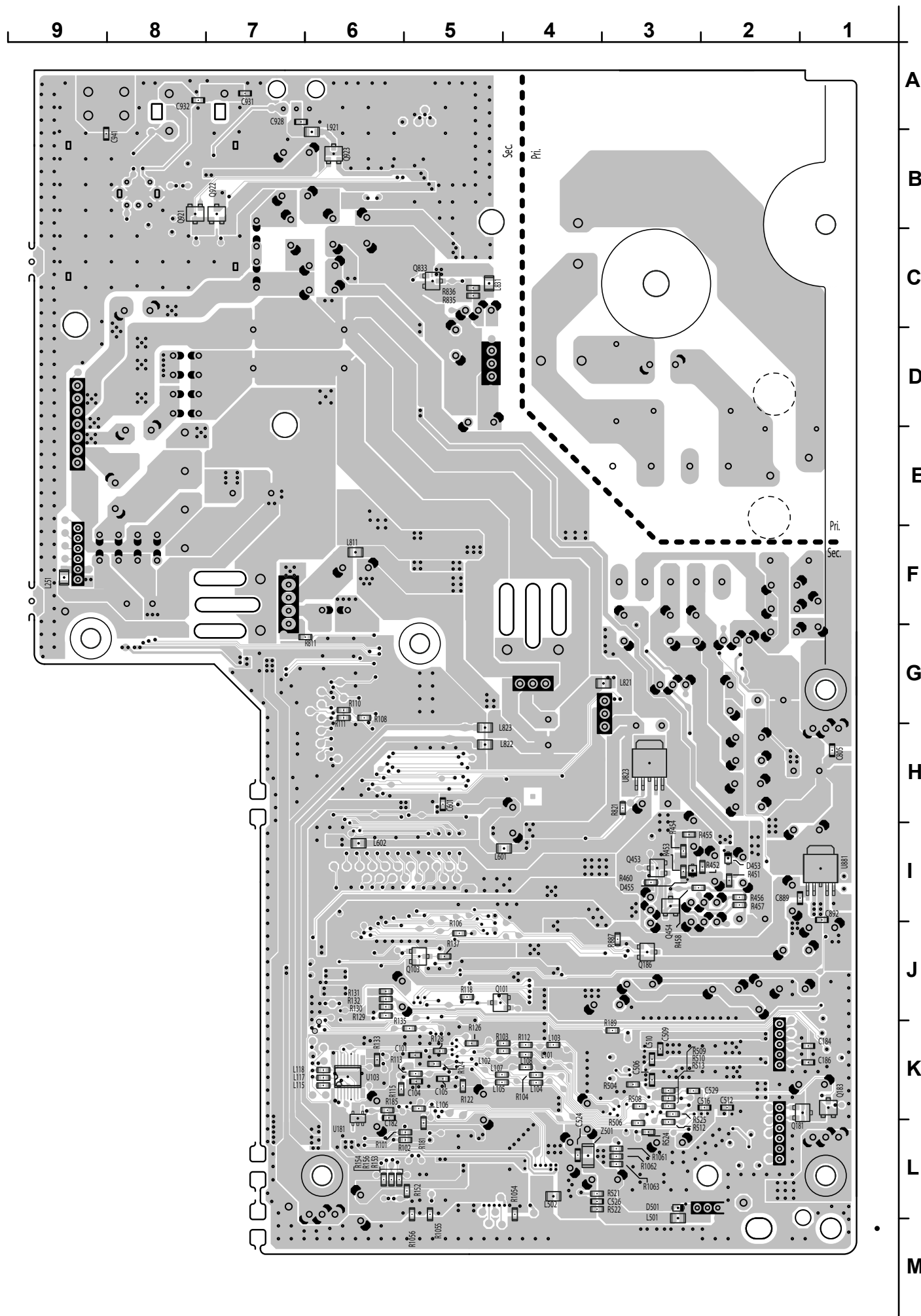

**鉛フリー半田**  
半田付けには、鉛フリー半田 (Sn-Ag-Cu) を使用してください。  
**Lead-free Solder**  
When soldering, use the Lead-free Solder (Sn-Ag-Cu).

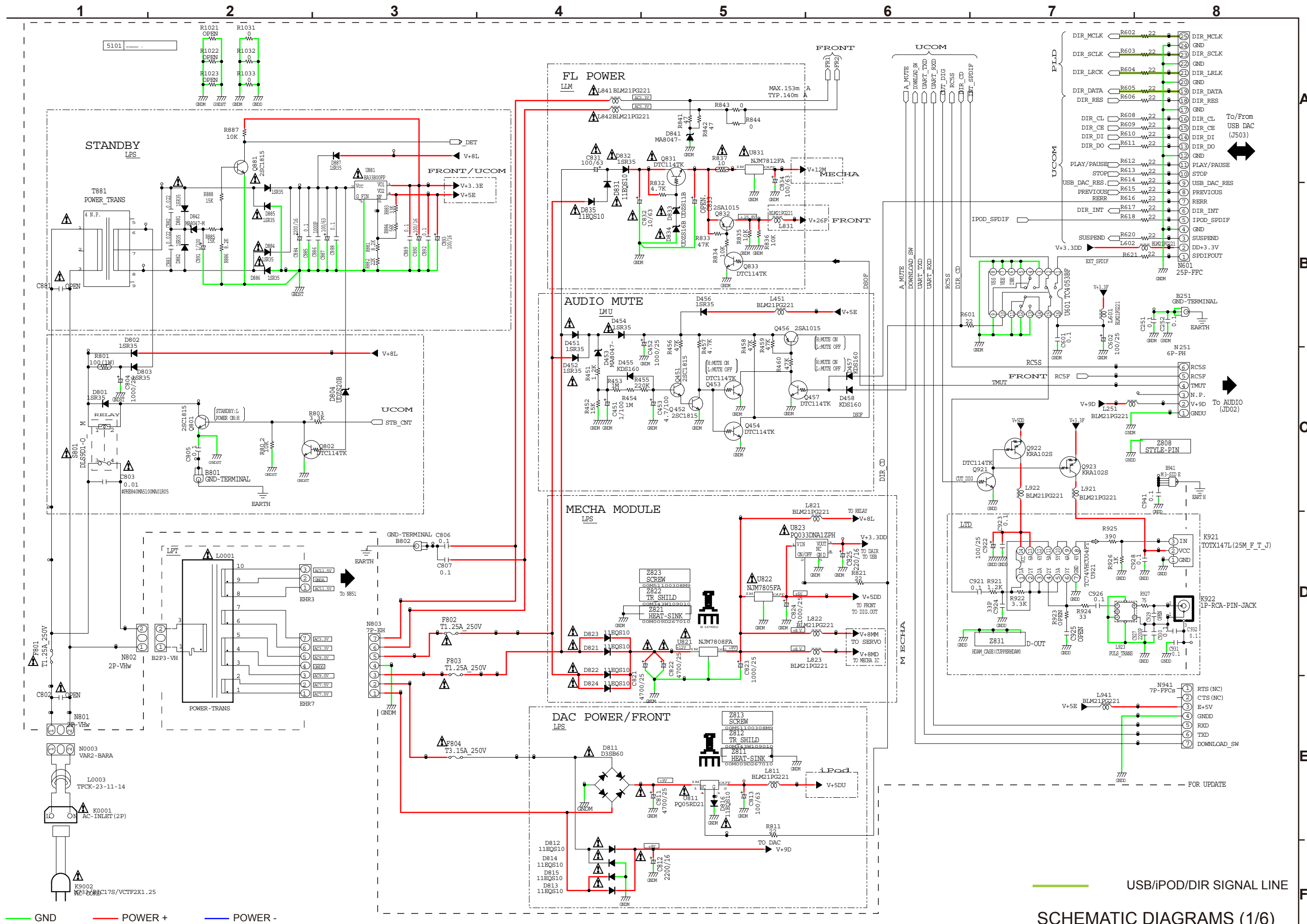

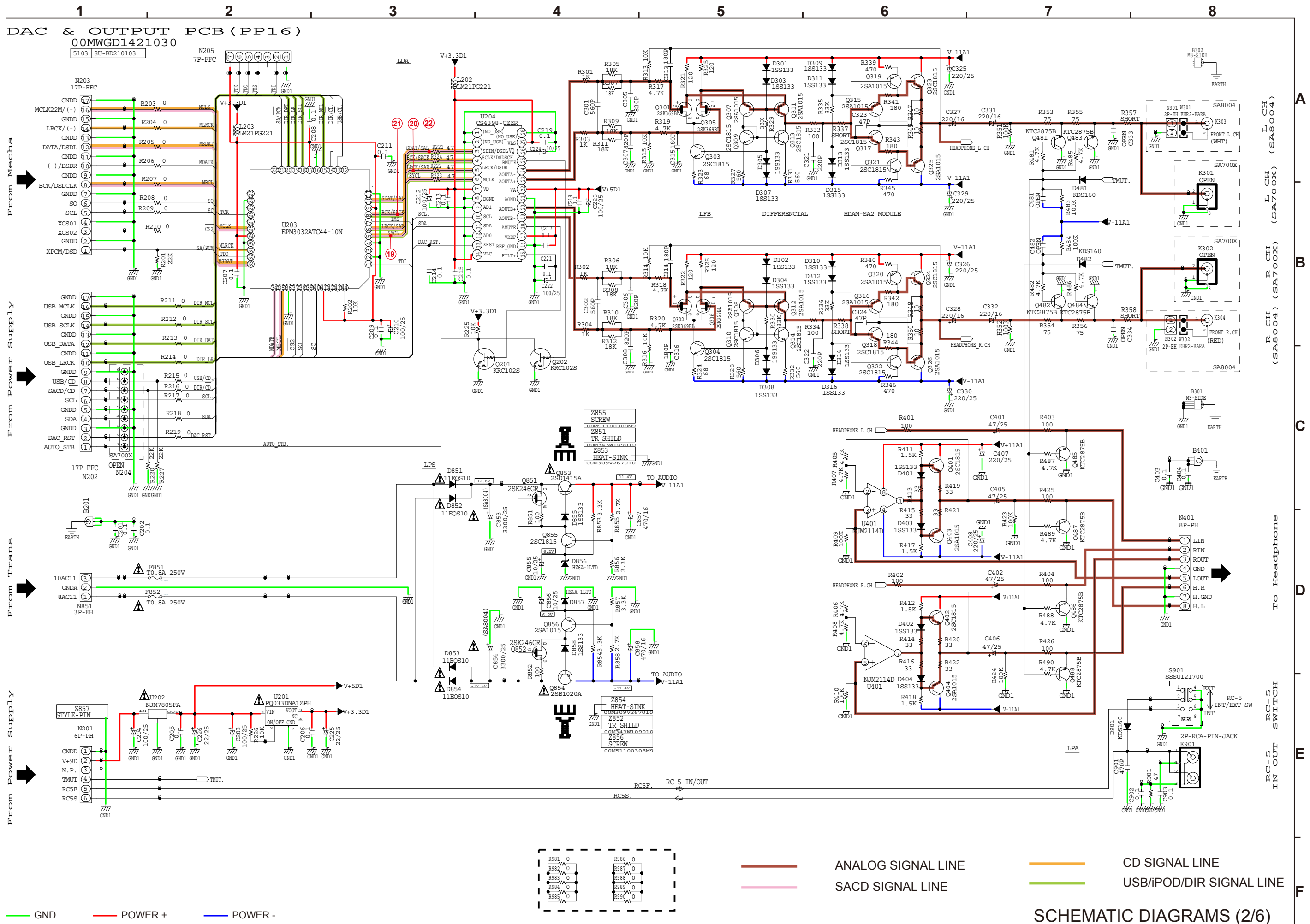

SCHMATIC DIAGRAMS (2/6)



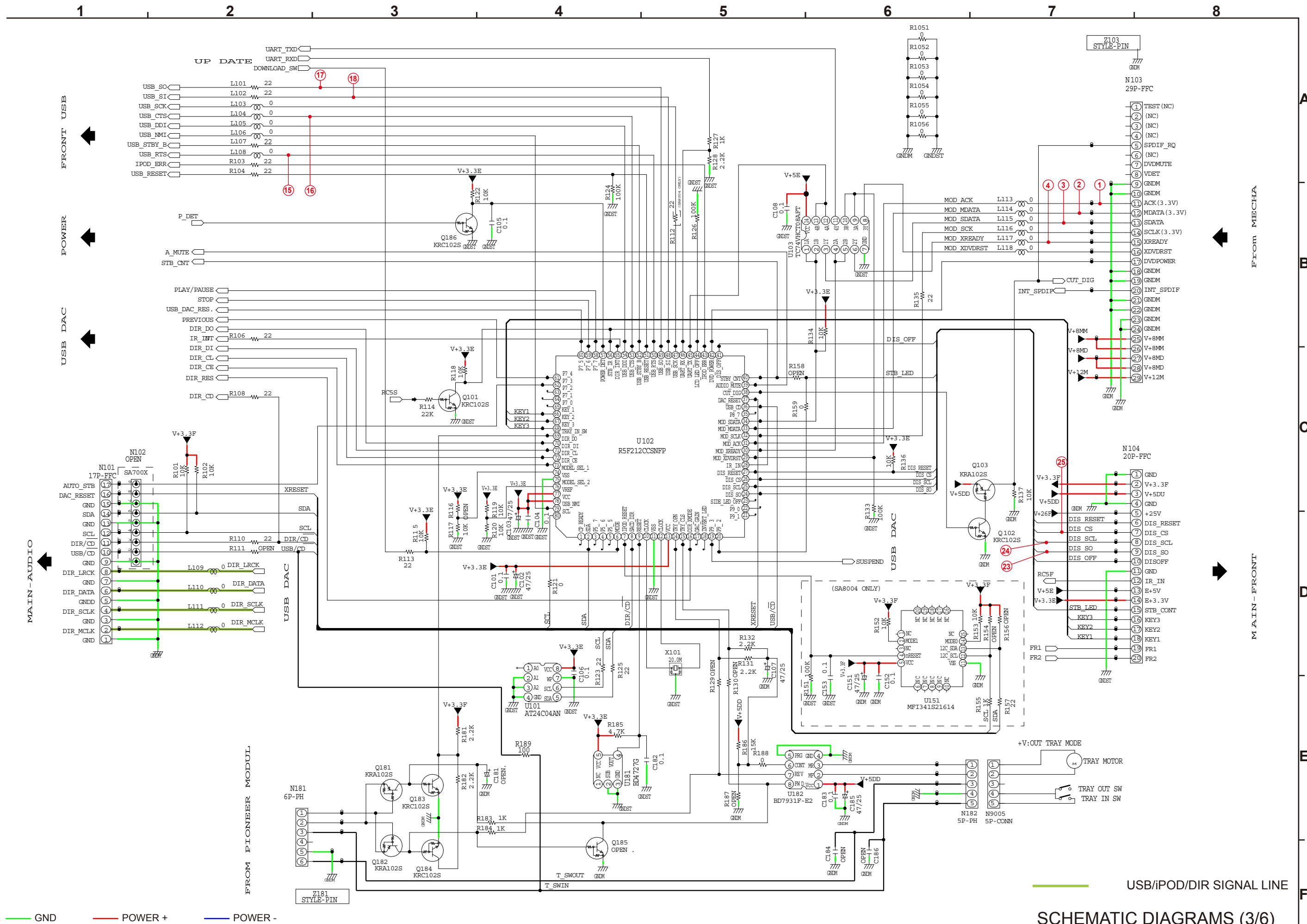

— GND      — POWER +      — POWER -

— USB/iPOD/DIR SIGNAL LINE  
SCHEMATIC DIAGRAMS (3/6)

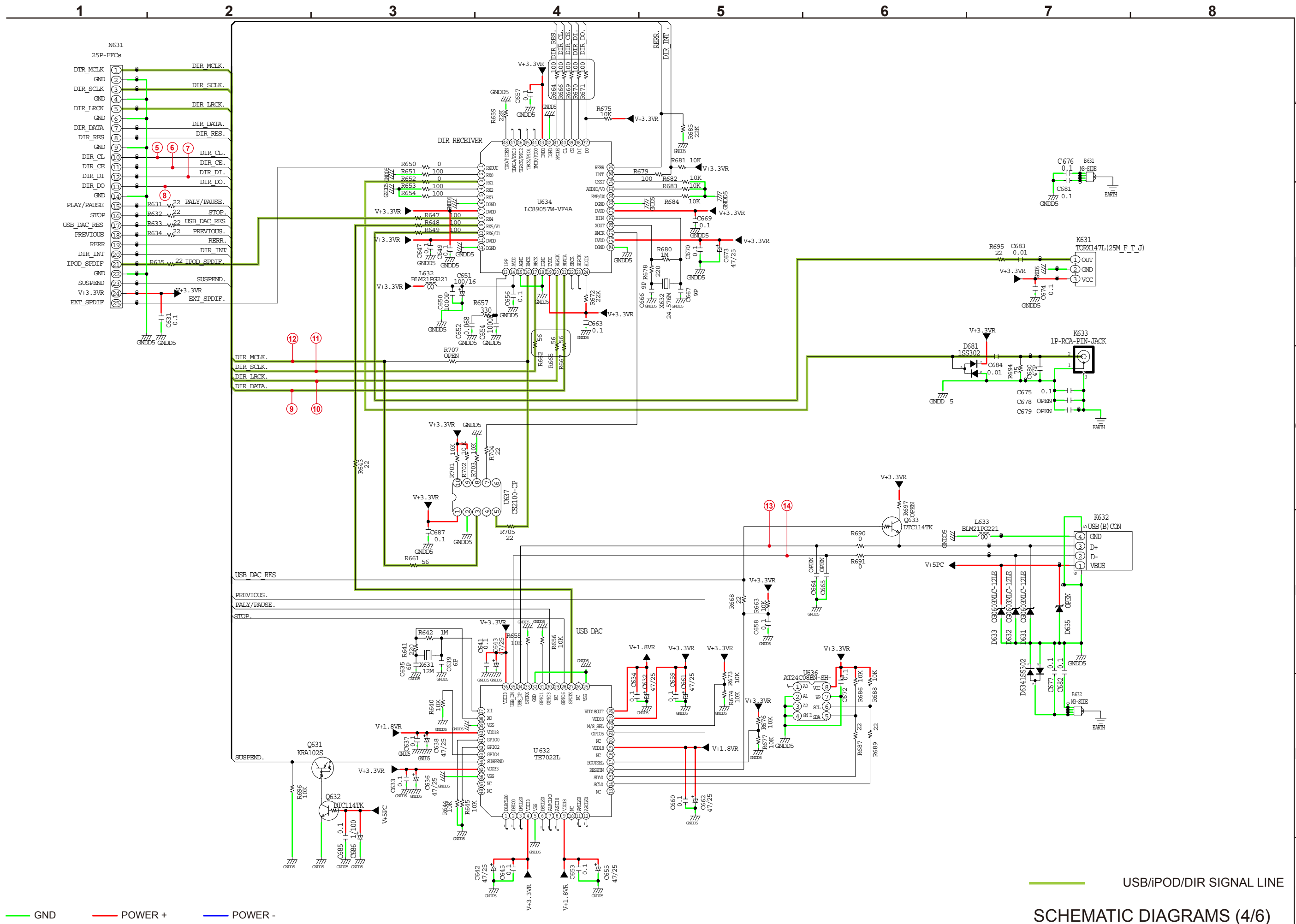

— GND   
 — POWER +   
 — POWER -

— USB/iPOD/DIR SIGNAL LINE  
 SCHEMATIC DIAGRAMS (4/6)

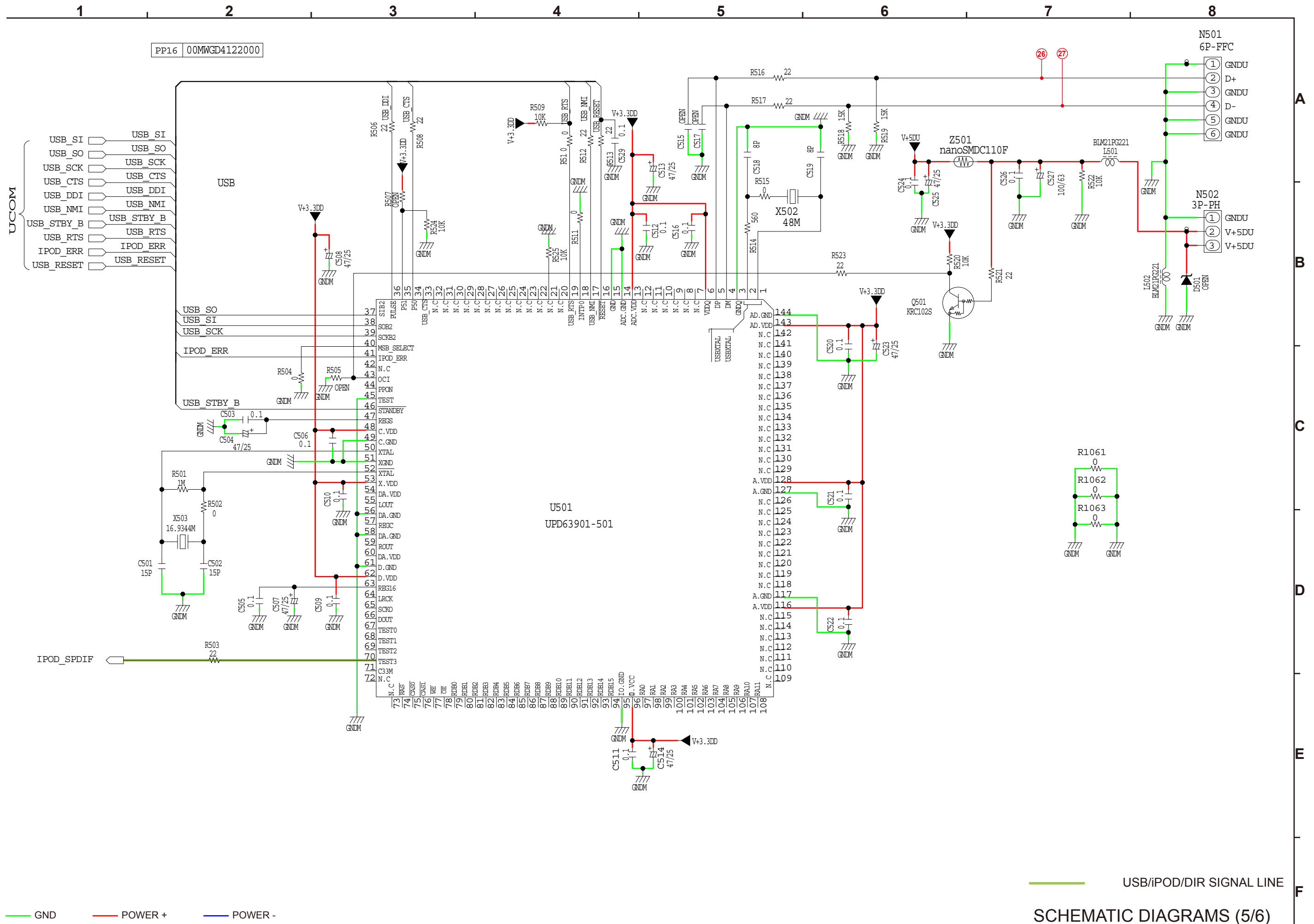

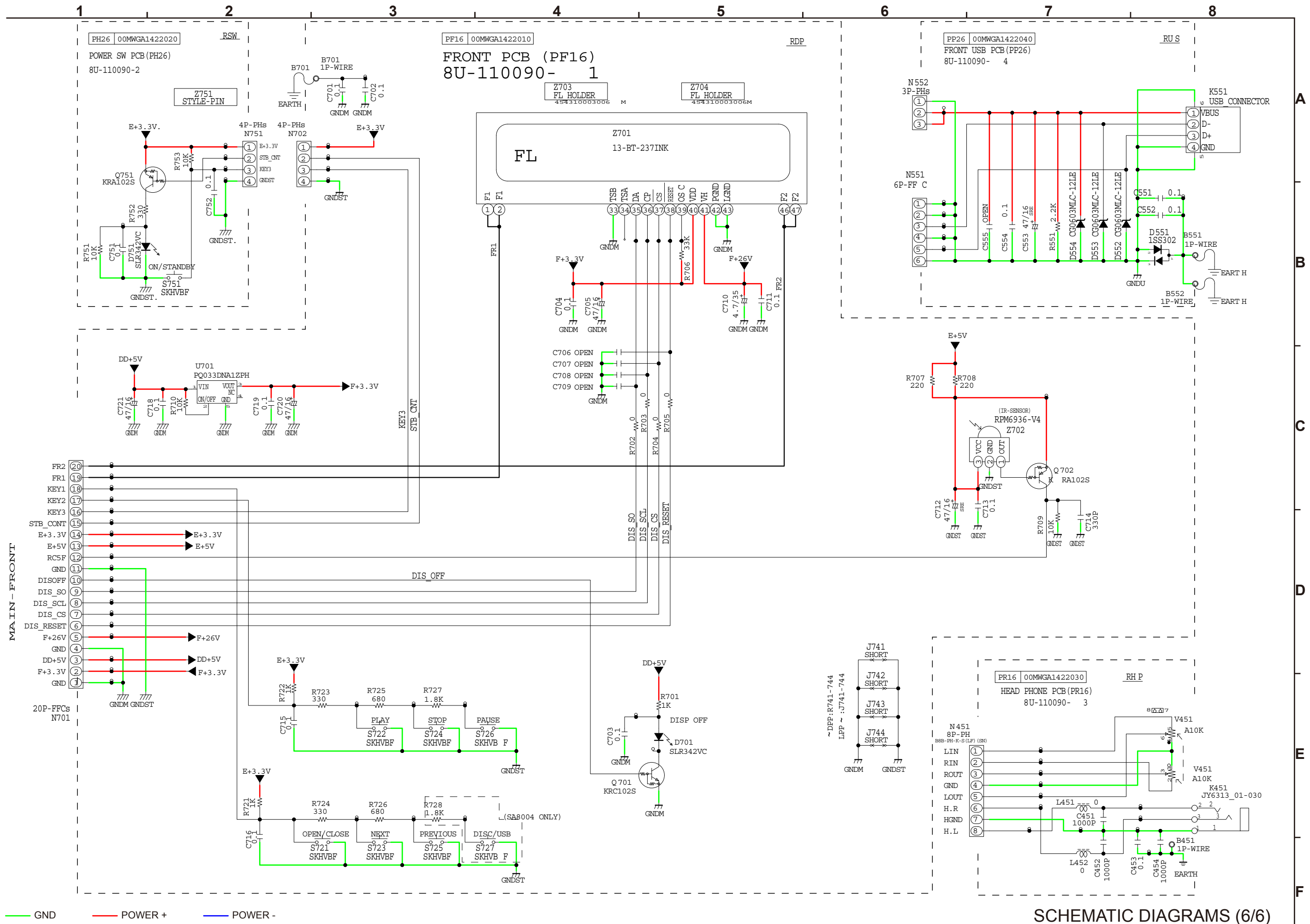

MAIN-FRONT

20P-FFCs  
N701

— GND    — POWER +    — POWER -

SCHEMATIC DIAGRAMS (6/6)



# EXPLODED VIEW

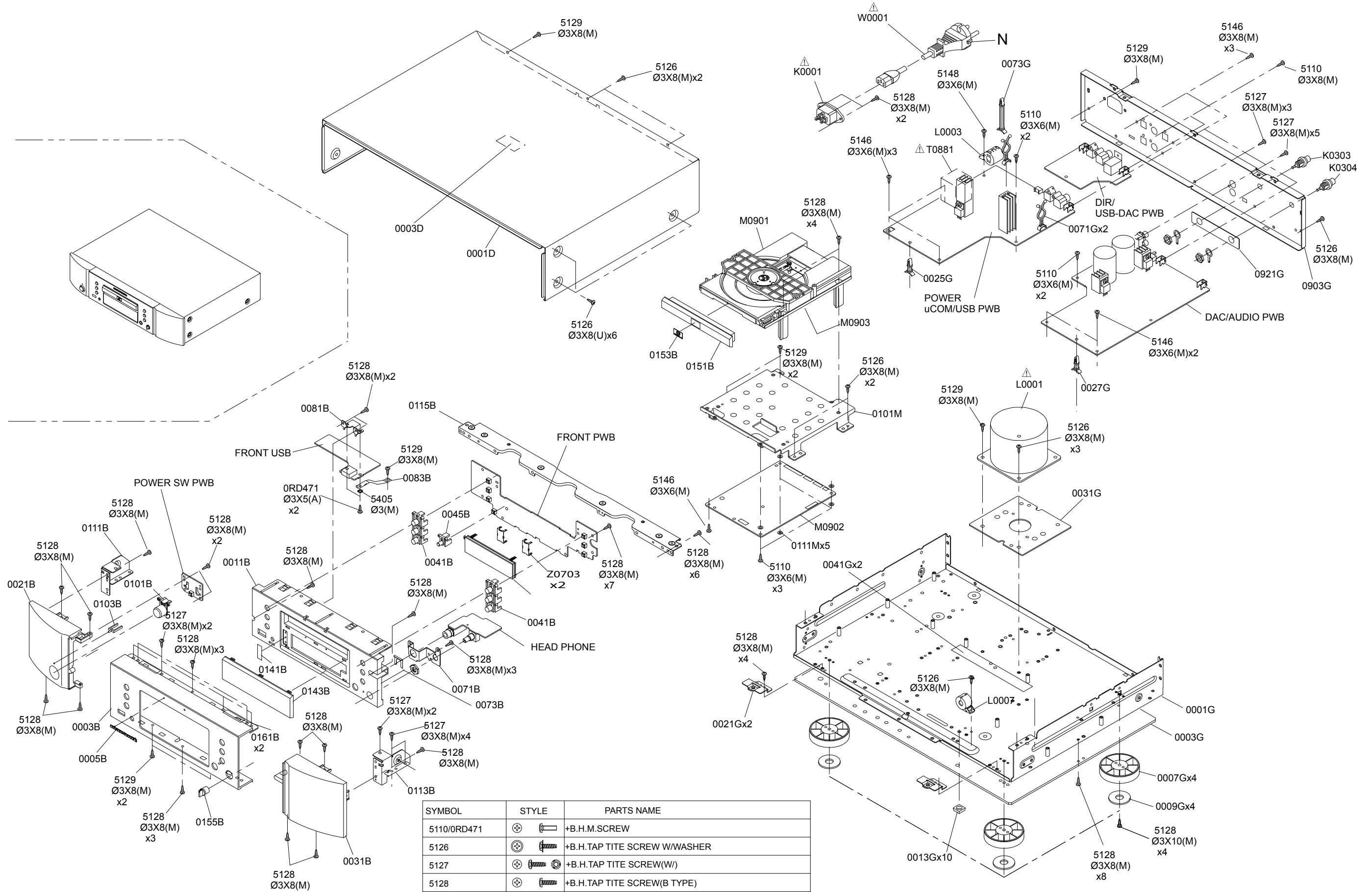

SYMBOL	STYLE	PARTS NAME
5110/0RD471		+B.H.M.SCREW
5126		+B.H.TAP TITE SCREW W/WASHER
5127		+B.H.TAP TITE SCREW(W/)
5128		+B.H.TAP TITE SCREW(B TYPE)
5129		+B.H.TAP TITE SCREW(W/T. L. WASHER)
5146		+B.H.M.SCREW(W/T.L.WASHER)
5148		+B.H.M.SCREW W/WASHER
5405		TOOTHED LOCK WASHERS

MARK	MATERIAL / FINISH
(M)	STEEL / COPPER

**WARNING:**  
Parts marked with this symbol have critical characteristics.  
Use ONLY replacement parts recommended by the manufacturer.

# PARTS LIST OF EXPLODED VIEW

\* Parts for which "nsp" is indicated on this table cannot be supplied.

\* P.W.B. ASS'Y for which "nsp" is indicated on this table cannot be supplied. When repairing the P.W.B. ASS'Y, check the board parts table and order replacement parts.

\* Part indicated with the mark "★" is not illustrated in the exploded view.

\* The parts listed below are for maintenance only, might differ from the parts used in the unit in appearances or dimensions.

**Note:** The symbols in the column "Remarks" indicate the following destinations.

U : North America model

N : Europe model

K : China model

B : Black model

SG : Silver gold model

Ref. No.	Part No.	Part Name	Remarks	Q'ty	New
	nsp	FRONT PCB ASSY	K	1	
	nsp	FRONT PCB ASSY	U	1	
	nsp	FRONT PCB ASSY	N	1	
	-	FRONT UNIT			
	-	POWER SW UNIT			
	-	HEAD PHONE UNIT			
	-	USB_UNIT			
	nsp	MAIN PCB ASSY	K	1	
	nsp	MAIN PCB ASSY	U	1	
	nsp	MAIN PCB ASSY	N	1	
	-	AUDIO UNIT			
	-	POWER_UCOM_DSP UNIT			
	-	DIR UNIT			
0003B	402410114034M	FRONT PANEL SA8004 SG	K1SG	1	*
0003B	402410114003M	FRONT PANEL SA8004 BL	U1B	1	*
0003B	402410114089M	FRONT PANEL SA-KI-PEARL-LITE SG	N1SG	1	*
0003B	402410114058M	FRONT PANEL SA-KI-PEARL-LITE BL	N1B	1	*
0005B	421410006004M	MARANTZ BADGE (AL) FOR M1 MODEL		1	
0011B	443510004038M	CHASSIS SG SA7003 33AK	SG	1	
0011B	443510004007M	CHASSIS BL SA7003 33AK	B	1	
0021B	402510115036M	ESCUCHEON L SG	SG	1	*
0021B	402510115005M	ESCUCHEON L BL	B	1	*
0031B	402510021032M	ESCUTCHEON R SG SA7003 33AK	SG	1	
0031B	402510021001M	ESCUTCHEON R BL SA7003 33AK	B	1	
0041B	411510019033M	BUTTON SG SA7003 33AK	SG	2	
0041B	411510019002M	BUTTON BL SA7003 33AK	B	2	
0045B	411510017037M	BUTTON SG SA8003 34AK	SG	1	
0045B	411510017006M	BUTTON BL SA8003 34AK	B	1	
0071B	nsp	BRACKET SA7003 33AK		1	
0073B	nsp	MET41-0191 (CLANP FOR HP JACK)		1	
0081B	nsp	BRACKET SA8003 34AK		1	
0083B	nsp	CONTACTOR SA8003 34AK		1	
0101B	411510021036M	BUTTON SG	SG	1	
0101B	411510021005M	BUTTON BL	B	1	
0103B	481510003006M	LENS		1	
0111B	nsp	BRACKET L SA7003 33AK		1	
0113B	nsp	BRACKET R SA7003 33AK		1	
0115B	nsp	STAY SA7003 33AK		1	
0141B	423510007002M	INDICATOR SA7003 33AK		1	
0143B	416510045006M	WINDOW FLD		1	*
0151B	418510001033M	ESCUTCHEON SG SA7003 33AK		1	
0153B	421410015008M	BADGE		1	*
0155B	00M24AW154120	KNOB SG	SG	1	
0155B	00M24AW154020	KNOB BL	B	1	

Ref. No.	Part No.	Part Name	Remarks	Q'ty	New
0161B	nsp	SHEET SA7003 33AK		2	
0001D	401310003033M	TOP COVER SG SA7003 33AK	SG	1	
0001D	401310003002M	TOP COVER BL SA7003 33AK	B	1	
0003D	nsp	SHEET DAMPER		1	*
0001G	nsp	CHASSIS SA7003 33AK	U,K	1	
0001G	nsp	CHASSIS SA7003 33AK	N	1	
0003G	nsp	LID BOTTM		1	
0007G	00M14AJ057210	LEGS SL		4	
0009G	00M14AJ056110	LEGS CUSHION		4	
0013G	nsp	BUSH SCREW		10	
0021G	nsp	BRACKET SA7003 33AK		2	
0025G	nsp	PCB SUPPORT RICHICO		1	
0027G	nsp	PCB SUPPORT RICHICO		1	
0031G	nsp	BRACKET SA7003 33AK		1	
0041G	nsp	PROTECTOR SHEET PET T0.5 22X140 SA8004		1	*
0073G	nsp	LCBS-18NOSJ 94V-2		1	
0903G	nsp	REAR PANEL SA8004 K	K	1	*
0903G	nsp	REAR PANEL SA-KI-PEARL-LITE N	N	1	*
0903G	nsp	REAR PANEL S8004 U	U	1	*
0921G	nsp	SHIELD REAR CP		1	
0101M	nsp	BRACKET SA7003 33AK		1	
0111M	nsp	WASHER		7	
△	K0001	00D2033996008	AC INLET (2P)	1	
	K0303	00MYT02011290	EW-2560T-LH-W	1	
	K0304	00MYT02011280	EW-2560T-LH-R	1	
△	L0001	00MTS56903030	!TROIDAL TRANS AC230V (N)	1	
△	L0001	00MTS56903030	!TROIDAL TRANS AC230V (N)	1	
△	L0001	00MTS56903020	!TROIDAL TRANS AC120V (U)	1	
	L0003	nsp	TFCK-23-11-14	1	
	L0007	nsp	FERRITE CORE TFCK-16813	1	
	M0901	311010001007M	LOADER UNIT	1	
	M0902	00MZK35AK0020	DB-APB105/XJ MAIN PWB ASSY	1	
	M0903	312010002010M	DB-VTV736/XCN TRAVERSE	1	
△	W0001	00D2062249001	AC CORD (E1C)	1	
△	W0001	00MZC01803080	# 2P AC CORD 10A 250V CLASS2	1	
△	W0001	00MZC01803100	# AC CORD UL/CSA 10A 125V	1	
	Z0703	nsp	HOLDER SA7003 33AK	2	
△	T0881	00D2336615002	POWER TRANS(MINI/E2)	1	
△	T0881	00D2336614003	POWER TRANS(MINI/E3)	1	
	★ 1	nsp	CONNECTIVE CORD VAR- 22CM	1	
	★ 2	00D0090295029	17P FFC(1.0)	1	
	★ 3	606050056000S	29P FFC 150mm(1.0)	1	
	★ 4	00MYU20155520	20PIN FFC CABLE UL2896	1	
	★ 5	nsp	5P-6P PH CON.CORD	1	
	★ 6	nsp	5P KR-KR RIBBON 450	1	
	★ 7	nsp	6P KR-KR CON.CORD	1	
	★ 8	00MYU17100520	SMCD-17X100-BDX6(BL)-P1.0-S4-M	1	
	★ 9	nsp	EHR2-BARA UL1430 AWG22 OFC	2	
	★ 10	nsp	PHR-PHR 8PIN L=24CM UL1061 AWG28	1	
	★ 11	00MYU06080520	SMCD-6X80-BDX6(BL)-P1.0-S4-M UL2896	1	
	★ 12	nsp	3P PH-PH CONN CORD	1	
	★ 13	00MYU25140520	SMCD-25X140-BDX6-P1.0-S4.0+4.0-M UL2896	1	
	★ 14	nsp	4P-4P PHR(WHT) UL1007 AWG26	1	

Ref. No.	Part No.	Part Name	Remarks	Q'ty	New
★ 15	606050039005S	FFC CABLE 24PIN 0.5MM PITCH L=11CM	W1001<->CN101	1	
★ 16	nsp	CONT.LABEL BASE(D&M)	0001S	1	
★ 17	nsp	CONT LABEL FILM	0002S	1	
★ 18	nsp	SHEET SA7003 33AK	0081G	2	
★ 19	nsp	SHEET	0131M	1	
★ 20	nsp	WIRE CLAMPER	0141M	2	
★ 21	544010193003D	POWER SW LABEL(E1C)	K : 0171B	1	
★ 22	nsp	WIRE CLAMPER	0801G	9	
★ 23	nsp	USB-4 SLEEVE FERRITE CLAMP	L0004	1	
★ 24	nsp	HF70SH28-2-10 FPC FERRITE CORE	L0005	1	
★ 25	nsp	FERRITE CORE SSC-40-12	L0006	1	
★ 26	nsp	ALUMINUM TAPE	0202M(N101<->N202)	1	
★ 27	nsp	ALUMINUM TAPE(W=60)	0203M(N601<->N631)	1	
★ 28	nsp	CLAMPER	0071G	2	
<b>SCREWS</b>					
5110	nsp	SCREW		10	
5126	nsp	B.T.SCREW EX600240		14	
5127	nsp	SCREW		72	
5128	nsp	SCREW		4	
5129	nsp	SCREW		9	
5146	nsp	SCREW		10	
5150	nsp	SCREW		1	
4713	nsp	3X5 CBS		2	

## EXPLODED VIEW OF CD MECHANISM UNIT

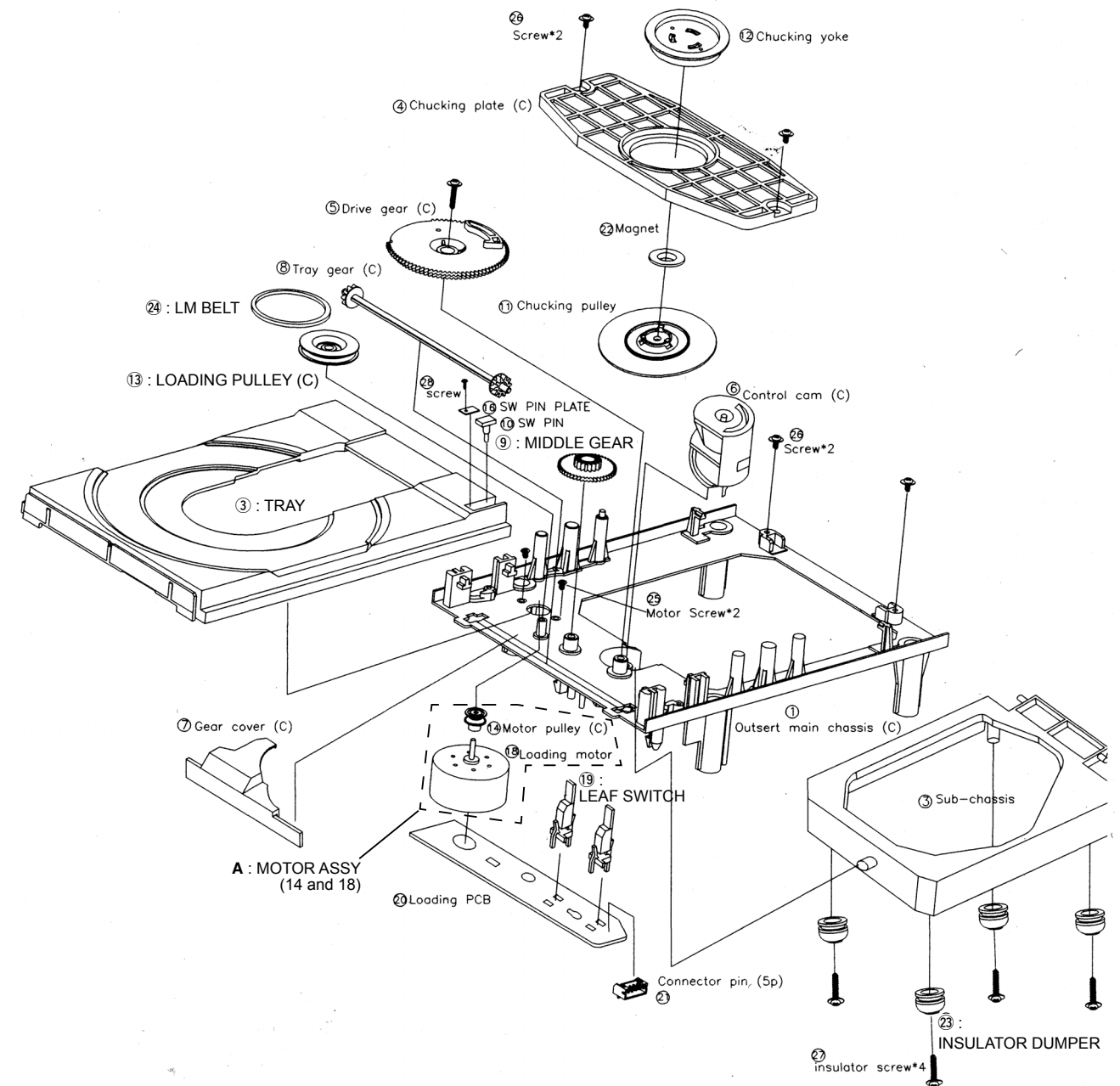

## PARTS LIST OF CD MECHANISM UNIT

\*Parts for which "nsp" is indicated on this table cannot be supplied.

\*Part indicated with the mark "★" is not illustrated in the exploded view.

\*The parts listed below are for maintenance only, might differ from the parts used in the unit in appearances or dimensions.

**Note:** The symbols in the column "Remarks" indicate the following destinations.

U : North America model  
B : Black model

N : Europe model  
SG : Silver gold model

K : China model

Ref.No.	Part No.	Part Name	Remarks	Q'ty	New
2	995419000010S	TRAY	SW00-1015-00	1	
9	995463000020S	MIDDLE GEAR	SW00-1009-00	1	
13	995462000030S	LOADING PULLEY(C)	SW00-1012-00	1	
19	995669000040S	LEAF SWITCH	SW00-3002-00	1	
23	995474000050S	INSULATOR DUMPER	SW00-4011-00	1	
24	995466000060S	LM BELT	SW00-4005-00	1	
A	995684000070S	MOTOR ASSY (14 and 18)	SW10-3001-00	1	

## PACKING VIEW

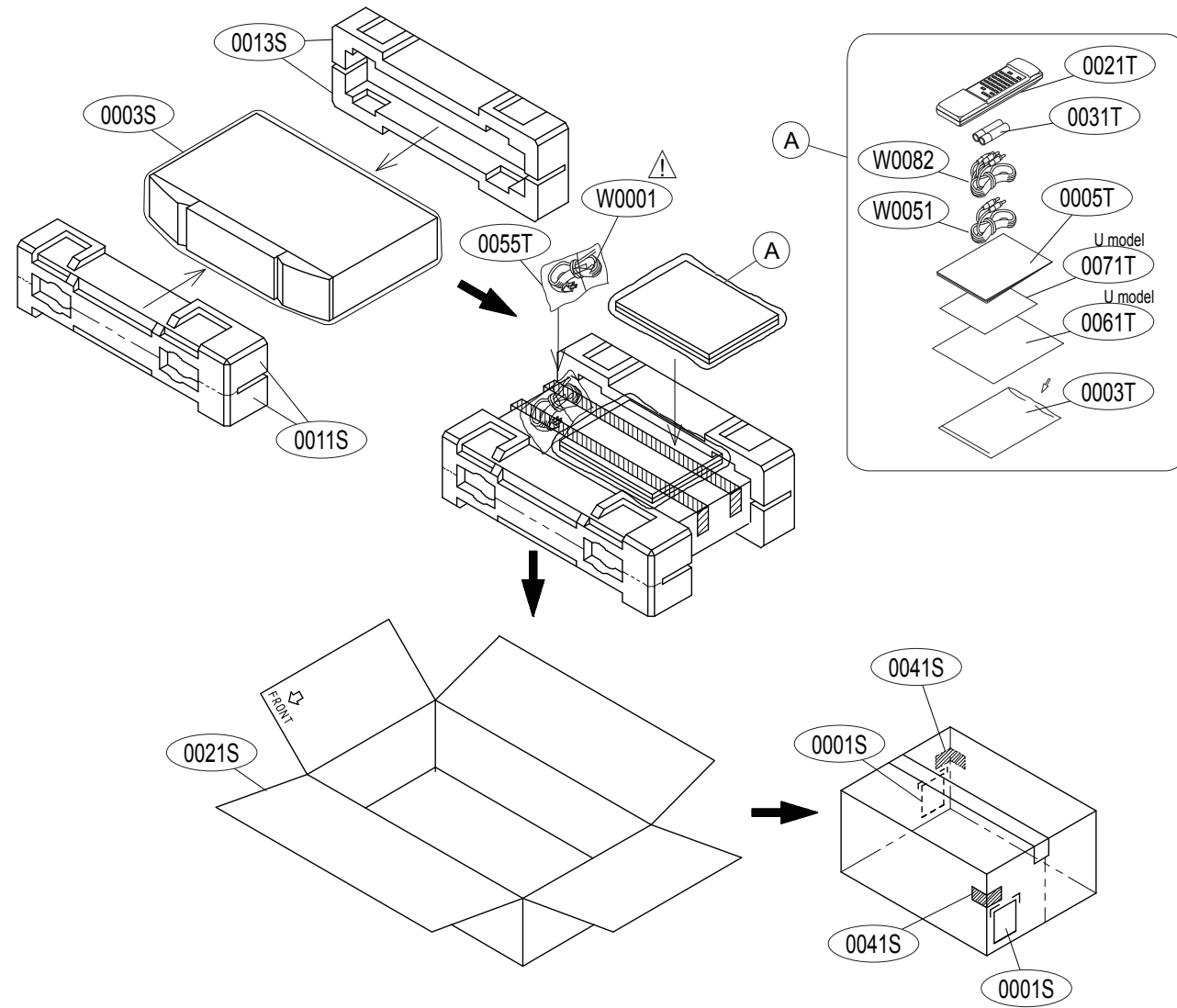

Ref. No.	Part No.	Part Name	Remarks	Q'ty	New
	0055T	nsp	POLY COVER	1	
	0061T	nsp	WARRANTY USA	1	
	0071T	nsp	WARRANTY CANADA	1	
△	W0001	00D2062249001	AC CORD (E1C)	1	
△	W0001	00MZC01803080	# 2P AC CORD 10A 250V CLASS2	1	
△	W0001	00MZC01803100	# AC CORD UL/CSA 10A 125V	1	
	W0051	nsp	TWIN SHIELDED WIRE WITH RCA PLUGS	1	
	W0082	nsp	2P PIN CORD	1	
	★ 0051S	nsp	CLEAR LABEL(66X27 T0.05)	1	
	★ 0051S	nsp	CLEAR LABEL	1	

## PARTS LIST OF PACKING & ACCESSORIES

\* Parts for which "nsp" is indicated on this table cannot be supplied.

\* The parts listed below are for maintenance only, might differ from the parts used in the unit in appearances or dimensions.

**Note:** The symbols in the column "Remarks" indicate the following destinations.

U : North America model  
B : Black model

N : Europe model  
SG : Silver gold model

K : China model

Ref. No.	Part No.	Part Name	Remarks	Q'ty	New
	0001S	nsp	CONT.LABEL BASE(D&M)	1	
	0003S	nsp	CABINET COVER	1	
	0011S	533510071108M	CUSHION FRONT	1	*
	0013S	533510071115M	CUSHION REAR	1	*
	0021S	531210138008M	PACKING CASE SA8004	1	*
	0021S	531210138015M	PACKING CASE SA-KI-PEARL-LITE	1	*
	0041S	nsp	LABEL FOR PKG SG	2	
	0003T	nsp	POLYETHY BAG	1	
	0005T	541110495051M	USER MANUAL (K)	1	*
	0005T	541110495037M	USER MANUAL (N)	1	*
	0005T	541110495020M	USER MANUAL (U)	1	*
	0021T	307010083000M	REMOTE COMMANDER RC004SA	1	*
	0031T	nsp	BATTERY(R03X2)	1	

# SEMICONDUCTORS

Only major semiconductors are shown, general semiconductors etc. are omitted to list.  
The semiconductor which described a detailed drawing in a schematic diagram are omitted to list.

## 1. IC's

### LC89057W-VF4 (MAIN :U634)

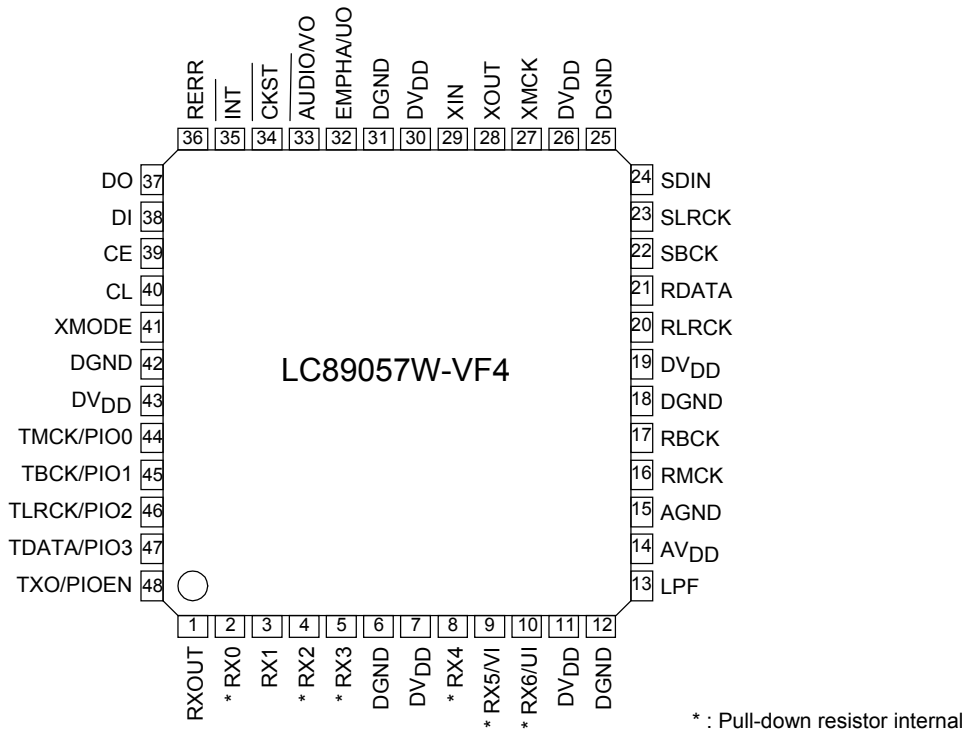

### LC89057W-VF4 Block diagram

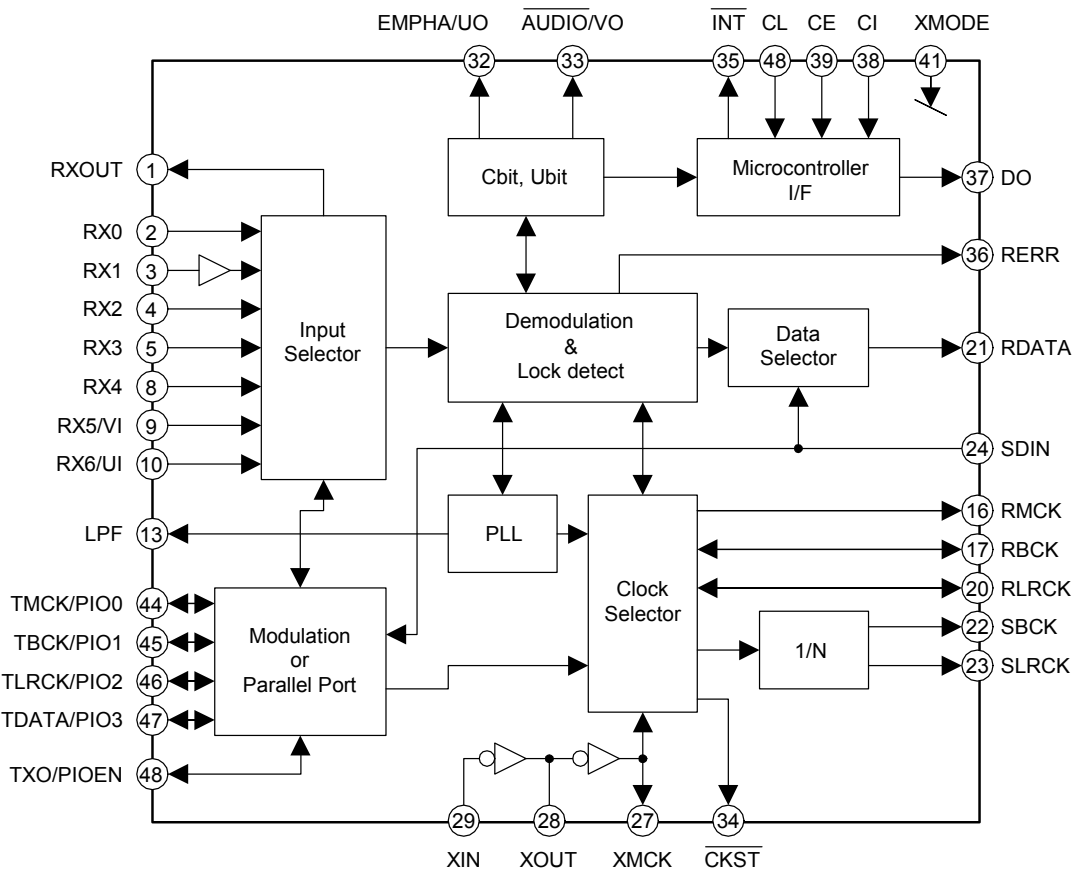

## LC89057W-VF4 Terminal Functions

Pin No.	Name	I/O	Function
1	RXOUT	O	Output pin of Input bi-phase selection data
2	RX0	I <sub>5</sub>	Input pin of TTL-compatible digital data
3	RX1	I	Digital data input pin with built-in amplifier that supports coaxial
4	RX2	I <sub>5</sub>	Input pin of TTL-compatible digital data
5	RX3	I <sub>5</sub>	Input pin of TTL-compatible digital data
6	DGND		Digital GND
7	DV <sub>DD</sub>		Digital power supply
8	RX4	I <sub>5</sub>	Input pin of TTL-compatible digital data
9	RX5/VI	I <sub>5</sub>	TTL-compatible digital data    Validity flag input pin for modulation
10	RX6/UI	I <sub>5</sub>	TTL-compatible digital data    User data input pin for modulation
11	DV <sub>DD</sub>		Digital power supply for PLL
12	DGND		Digital GND for PLL
13	LPF	O	PLL loop filter connection pin
14	AV <sub>DD</sub>		Analog power supply for PLL
15	AGND		Analog GND for PLL
16	RMCK	O	R system clock output pin (256fs, 512fs, XIN, VCO)
17	RBCK	O/I	R bit clock input/output pin (64fs)
18	DGND		Digital GND
19	DV <sub>DD</sub>		Digital power supply
20	RLRCK	O/I	R LR clock input/output pin (fs)
21	RDATA	O	Output pin of serial audio data
22	SBCK	O	S bit clock output pin (32fs, 64fs, 128fs)
23	SLRCK	O	S LR clock output pin (fs/2, fs, 2fs)
24	SDIN	I <sub>5</sub>	Input pin of serial audio data
25	DGND		Digital GND
26	DV <sub>DD</sub>		Digital power supply
27	XMCK	O	Oscillation amplifier output pin
28	XOUT	O	Quartz resonator connection output pin
29	XIN	I	Quartz resonator connection, input pin of external supply clock (24.576 MHz or 12.288 MHz)
30	DV <sub>DD</sub>		Digital power supply
31	DGND		Digital GND
32	EMPHA/UO	I/O	Emphasis information    U data output    Chip address setting pin
33	AUDIO/VO	I/O	Non-PCM detection    V flag output    Chip address setting pin
34	CKST	I/O	Output of clock switch transitional period signal    Demodulation master or slave function switch pin
35	INT	I/O	Interrupt output for Microcontroller (Possible to select an interrupt factor.)    Modulation or general-purpose I/O switch pin
36	RERR	O	PLL clock error, data error flag output
37	DO	O	Microcontroller I/F, read data output pin (3-state)
38	DI	I <sub>5</sub>	Microcontroller I/F, write data input pin
39	CE	I <sub>5</sub>	Microcontroller I/F, chip enable input pin
40	CL	I <sub>5</sub>	Microcontroller I/F, clock input pin
41	XMODE	I <sub>5</sub>	System reset input pin
42	DGND		Digital GND
43	DV <sub>DD</sub>		Digital power supply
44	TMCK/PIO0	I/O	256fs system clock input for modulation    General-purpose I/O input/output pin
45	TMCK/PIO1	I/O	64fs bit clock input for modulation    General-purpose I/O input/output pin
46	TLRCK/PIO2	I/O	fs clock input for modulation    General-purpose I/O input/output pin
47	TLRCK/PIO3	I/O	serial audio data input for modulation    General-purpose I/O input/output pin
48	TXO/PIOEN	O/I	Modulation data output    General-purpose I/O enable input pin

- 1) Withstand voltage input/output: I or O = -0.3 to 3.6V, I<sub>5</sub> = -0.3 to 5.5V
- 2) Pins 32 and 33 are input pins for chip address setting, when pin 41 = "L".
- 3) Pin 34 is a demodulation function master or an input pin for slave setting, when pin 41 = "L".
- 4) Pin 35 is a modulation function or an input pin for general-purpose I/O function switch setting, when pin 41 = "L".
- 5) ON/OFF for all power supplies must be done at the same timing as a latch-up countermeasure.

## 120 dB, 192 kHz Multi-Bit DAC with Volume Control

### Features

- ◆ Advanced Multi-bit Delta-Sigma Architecture
  - 120 dB Dynamic Range
  - -107 dB THD+N
  - Low Clock Jitter Sensitivity
  - Differential Analog Outputs
- ◆ PCM input
  - 102 dB of Stopband Attenuation
  - Supports Sample Rates up to 192 kHz
  - Accepts up to 24 bit Audio Data
  - Supports All Industry Standard Audio Interface Formats
  - Selectable Digital Filter Response
  - Volume Control with 1/2 dB Step Size and Soft Ramp
  - Flexible Channel Routing and Mixing
  - Selectable De-Emphasis
- ◆ Supports Stand-Alone or I<sup>2</sup>C/SPI™ Configuration
  - Embedded Level Translators
  - 1.8 V to 5 V Serial Audio Input
  - 1.8 V to 5 V Control Data Input
- ◆ Direct Stream Digital (DSD)
  - Dedicated DSD Input Pins
  - On-Chip 50 kHz Filter to Meet Scarlet Book SACD Recommendations
  - Matched PCM and DSD Analog Output Levels
  - Non-Decimating Volume Control with 1/2 dB Step Size and Soft Ramp
  - DSD Mute Detection
  - Supports Phase-Modulated Inputs
  - Optional Direct DSD Path to On-Chip Switched Capacitor Filter
- ◆ Control Output for External Muting
  - Independent Left and Right Mute Controls
  - Supports Auto Detection of Mute Output Polarity
- ◆ Typical Applications
  - DVD Players
  - SACD Players
  - A/V Receivers
  - Professional Audio Products

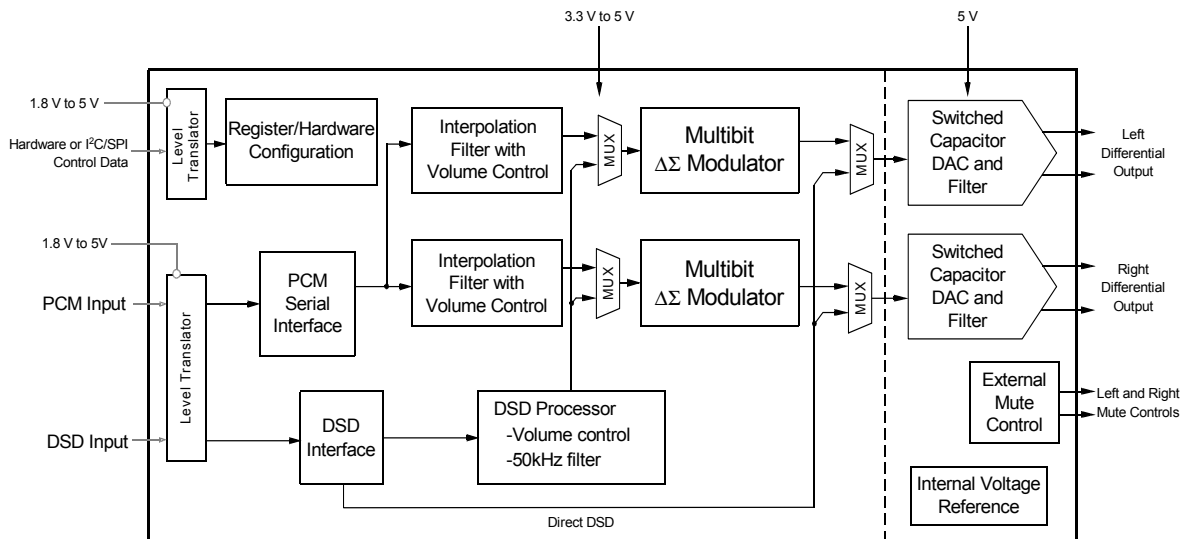

## CS4398 (MAIN : U204)

DSD_B	1	28	DSD_A
DSD_SCLK	2	27	VLS
SDIN	3	26	VQ
SCLK	4	25	AMUTEC
LRCK	5	24	AOUTA-
MCLK	6	23	AOUTA+
VD	7	22	VA
DGND	8	21	AGND
M3 (AD1/CDIN)	9	20	AOUTB+
M2 (SCL/CCLK)	10	19	AOUTB-
M1 (SDA/CDOUT)	11	18	BMUTEC
M0 (AD0/ $\overline{\text{CS}}$ )	12	17	VREF
RST	13	16	REF_GND
VLC	14	15	FILT+

## CS4398 Terminal Functions

Pin Name	Pin #	Pin Description
DSD_A	28	<b>Direct Stream Digital Input (Input)</b> - Input for Direct Stream Digital serial audio data.
DSD_B	1	
DSD_SCLK	2	<b>DSD Serial Clock (Input)</b> - Serial clock for the Direct Stream Digital audio interface.
SDIN	3	<b>Serial Audio Data Input (Input)</b> - Input for two's complement serial audio data.
SCLK	4	<b>Serial Clock (Input)</b> - Serial clock for the serial audio interface.
LRCK	5	<b>Left Right Clock (Input)</b> - Determines which channel, Left or Right, is currently active on the serial audio data line.
MCLK	6	<b>Master Clock (Input)</b> - Clock source for the delta-sigma modulator and digital filters.
VD	7	<b>Digital Power (Input)</b> - Positive power for the digital section.
DGND	8	<b>Digital Ground (Input)</b> - Ground reference for the digital section.
RST	13	<b>Reset (Input)</b> - The device enters system reset when enabled.
VLC	14	<b>Control Port Power (Input)</b> - Positive power for Control Port I/O.
FILT+	15	<b>Positive Voltage Reference (Output)</b> - Positive reference voltage for the internal sampling circuits.
REF_GND	16	<b>Reference Ground (Input)</b> - Ground reference for the internal sampling circuits.
VREF	17	<b>Voltage Reference (Input)</b> - Positive voltage reference for the internal sampling circuits.
BMUTEC	18	<b>Mute Control (Output)</b> - The Mute Control pin is active during power-up initialization, muting, power-down or if the master clock to left/right clock frequency ratio is incorrect. During reset, these outputs are set to a high impedance.
AMUTEC	25	
AOUTB+	20	<b>Differential Right Channel Analog Output (Output)</b> - The full-scale differential analog output level is specified in the Analog Characteristics specification table.
AOUTB-	19	
AGND	21	<b>Analog Ground (Input)</b> - Ground reference for the analog section.
VA	22	<b>Analog Power (Input)</b> - Positive power for the analog section.
AOUTA+	23	<b>Differential Left Channel Analog Output (Output)</b> - The full-scale differential analog output level is specified in the Analog Characteristics specification table.
AOUTA-	24	
VQ	26	<b>Quiescent Voltage (Output)</b> - Filter connection for internal quiescent voltage.
VLS	27	<b>Serial Audio Interface Power (Input)</b> - Positive power for serial audio interface I/O.
Stand-Alone Mode Definitions		
M3	9	<b>Mode Selection (Input)</b> - Determines the operational mode of the device.
M2	10	
M1	11	
M0	12	
Control Port Mode Definitions		
AD1/CDIN	9	<b>Address Bit 1 (I<sup>2</sup>C) / Control Data Input (SPI) (Input)</b> - AD1 is a chip address pin in I <sup>2</sup> C mode; CDIN is the input data line for the Control Port interface in SPI mode.
SCL/CCLK	10	<b>Serial Control Port Clock (Input)</b> - Serial clock for the serial Control Port.
SDA/CDOUT	11	<b>Serial Control Data (I<sup>2</sup>C) / Control Data Output (SPI) (Input/Output)</b> - SDA is a data I/O line in I <sup>2</sup> C mode. CDOUT is the output data line for the Control Port interface in SPI mode.
AD0/ $\overline{\text{CS}}$	12	<b>Address Bit 0 (I<sup>2</sup>C) / Control Port Chip Select (SPI) (Input)</b> - AD0 is a chip address pin in I <sup>2</sup> C mode; $\overline{\text{CS}}$ is the chip select signal for SPI format.



# R5F212CCSNFP (MAIN :U102)

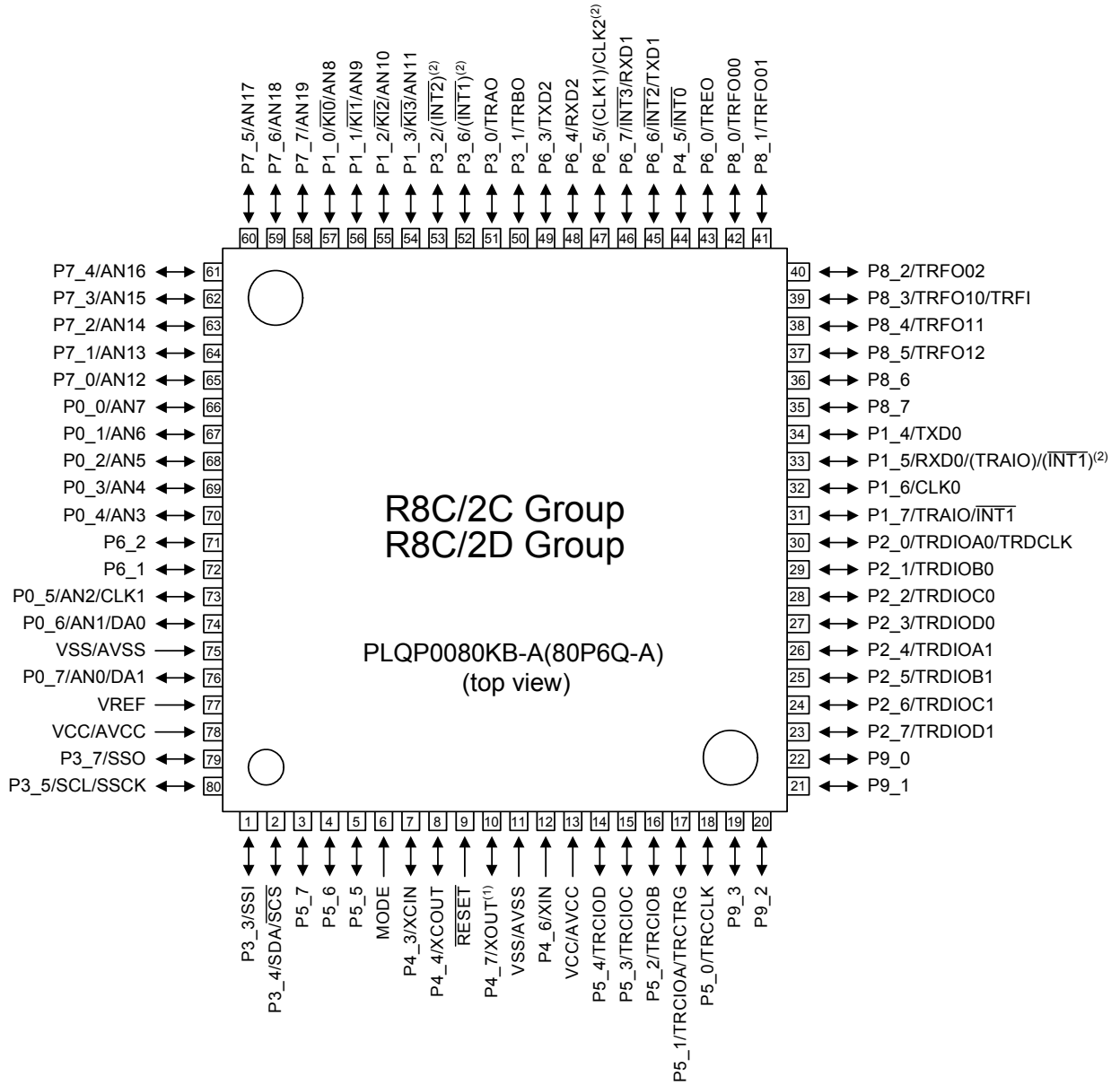

**NOTES:**

1. P4\_7/XOUT are an input-only port.
2. Can be assigned to the pin in parentheses by a program.
3. Confirm the pin 1 position on the package by referring to the package dimensions.

## R5F212CCSNFP Block diagram

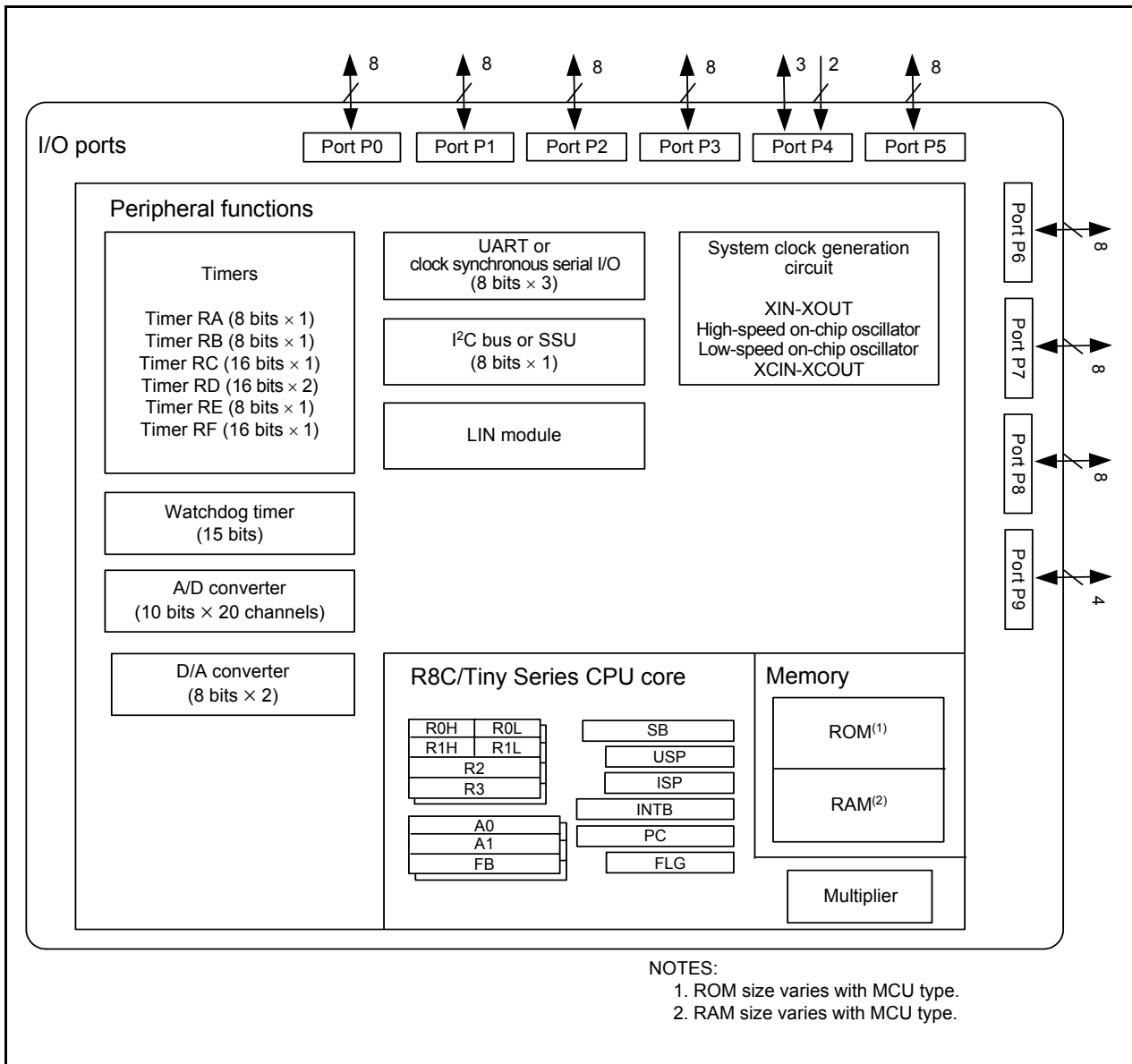

## CS4398 Terminal Functions

PIN	PORT	NAME	I/O		INITIAL	FUNCTION
			NOR MAL	STBY		
1	P3_3	CP_READY	I	I	-	IPOD READY
2	P3_4	SDA	I/O	I	H	IIC DATA
3	P5_7	-	I	I	L	-
4	P5_6	-	I	I	L	-
5	P5_5	-	I	I	-	-
6	MODE	MODE	I	I	-	-
7	P4_3	IPOD_RESET	O	I	L	IPOD ATTESTATION IC RESET OUTPUT
8	P4_4	SACD_DIR	O	I	L	SIGNAL CHANGE OUTPUT POWER OF SACD AND DIR
9	RESET	RESET	I	I	-	-
10	XOUT	CLOCK	-	-	-	20MHz
11	VSS	VSS	-	-	-	GND
12	XIN	CLOCK	-	-	-	20MHz
13	VCC	VCC	-	-	-	3.3V
14	TRCIOD	TRY_OPN	O	I	L	TRAY OPEN OUTPUT PWM OUTPUT

PIN	PORT	NAME	I/O		INITIAL	FUNCTION
			NOR MAL	STBY		
15	TRCIOC	TRY_CLS	O	I	L	TRAY CLOSE OUTPUT PWM OUTPUT
16	P5_2	DIR_XMODE	O	I	L	DIR RESET OUTPUT
17	P5_1	DAC_GAIN	O	I	L	DAC GAIN CHANGE OUTPUT
18	P5_0	INVERT_LED	I	I	L	BALANCE OUTPUT POLARITY DISPLAY LED
19	P9_3	SUSPEND	I	I	-	USB DAC ENABLE SIGNAL
20	P9_2	STB_LED	O	O	H	STANDBY LED OUTPUT
21	P9_1	-	O	I	H	-
22	P9_0	-	O	I	H	-
23	P2_7	SIDE_LED_OFF	I	I	L	FRONT PANEL BLUE LED ON/OFF OUTPUT
24	P2_6	DIS_SO	O	I	H	FLD/LCD DATA OUT PUT
25	P2_5	DIS_SCL	O	I	H	FLD/LCD CLOCK OUT PUT
26	P2_4	DIS_CS	O	I	H	FLD/LCD CHIP SELECT OUT PUT
27	P2_3	DIS_RESET	O	I	L	FLD/LCD RESET OUT PUT
28	P2_2	IR_IN	I	I	-	REMOTE CONTROL INPUT
29	P2_1	MOD_XDVRST	O	I	L	MECHANISM MODULE RESET OUTPUT
30	P2_0	MOD_XREADY	O	I	H	MECHANISM MODULE XRDY OUTPUT
31	INT1	MOD_ACK	I	I	-	MECHANISM MODULE ACK INPUT
32	CLK0	MOD_SCLK	I	I	-	MECHANISM MODULE COMMUNICATION CLOCK INPUT
33	RXD0	MOD_MDATA	I	I	-	MECHANISM MODULE COMMUNICATION DATA INPUT
34	TXD0	MOD_SDATA	O	I	L	MECHANISM MODULE COMMUNICATION DATA OUTPUT
35	P8_7	-	I	I	-	-
36	P8_6	SACD_USB	O	I	L	THE SIGNAL CHANGE OF USB AND SACD
37	P8_5	DAC_RESET	O	I	L	DAC RESET OUTPUT
38	P8_4	CUT_DIG	O	I	L	DIGITAL OUT ON/OFF CONTROL
39	P8_3	AUDIO_MUTE	O	I	H	ANALOG OUT MUTE CONTROL SIGNAL
40	P8_2	STBY_CNT	O	O	H	STANDBY CONTROL SIGNAL
41	P8_1	DIS_OFF	O	I	L	DISPLAY OFF LED OUTPUT
42	P8_0	DVD_POWER	O	I	H	MECHANISM MODULE POWER SUPPLY CONTROL
43	P6_0	IPOD_ERR	I	I	-	ISOCRONOS COMMUNICATION ERROR DETECTION
44	P4_5	LCD_LED_OFF	I	I	L	LCD BACK LIGHT-OFF SIGNAL
45	TXD1	UART_TX	O	I	H	FOR EXTERNAL UART COMMUNICATION
46	RXD1	UART_RX	I	I	-	FOR EXTERNAL UART COMMUNICATION
47	CLK2	USB_SCK	O	I	H	USB IC COMMUNICATION CLOCK INPUT
48	RXD2	USB_SI	I	I	-	USB IC COMMUNICATION DATA INPUT
49	TXD2	USB_SO	O	I	H	USB IC COMMUNICATION DATA OUTPUT
50	P3_1	USB_RTS	O	I	H	USB IC COMMUNICATION REQUEST OUTPUT
51	P3_0	USB_RESET	O	I	L	USB IC RESET OUTPUT
52	P3_6	USB_STBY_B	O	I	H	USB IC STANDBY CONTROL OUTPUT
53	INT2	USB_CTS	I	I	-	USB IC COMMUNICATION REQUEST INPUT
54	KI3	USB_DDI	I	I	-	USB IC ERROR DETECTION
55	KI2	DIR_INT	I	I	-	DIR IC INTERRUPT REQUEST INPUT
56	KI1	STB_IR	I	I	-	STANDBY RETURN INPUT
57	KI0	POWER_DET	I	I	-	POWER DOWN DETECTION
58	P7_7	-	O	I	L	-
59	P7_6	-	O	I	L	-
60	P7_5	USB DAC RES	O	I	L	USB DAC RESET OUTPUT SIGNAL
61	P7_4	-	O	I	L	
62	7_3	AUTO_STB	I	I	L	NO AUDIO SIGNAL DETECTION
63	P7_2	-	I	I	-	
64	P7_1	-	I	I	-	
65	P7_0	-	I	I	-	

PIN	PORT	NAME	I/O		INITIAL	FUNCTION
			NOR MAL	STBY		
66	AN7	KEY_1	I	I	-	KEY INPUT AD INPUT
67	AN6	KEY_2	I	I	-	KEY INPUT AD INPUT
68	AN5	KEY_3	I	I	-	KEY INPUT AD INPUT
69	AN4	TRAY_IN_SW	I	I	-	TRAY OPEN CLOSING TRIGGER INPUT AD INPUT
70	P0_4	DIR_DO	O	I	L	DIR IC DATA OUTPUT
71	P6_2	DIR_DI	I	I	-	DIR IC DATA INPUT
72	P6_1	DIR_CL	O	I	L	DIR IC CLOCK OUTPUT
73	P0_5	DIR_CE	O	I	L	DIR IC CHIP ENABLE OUTPUT
74	AN1	MODEL_SEL_1	I	I	-	MODEL SELECTION AD INPUT
75	VSS	VSS	-	-	-	GND
76	AN0	MODEL_SEL_2	I	I	-	MODEL SELECTION AD INPUT
77	VREF	VREF	-	-	-	3.3V
78	VCC	VCC	-	-	-	3.3V
79	P3_7	USB_NMI	I	I	-	USB IC STANDBY DETECTION
80	P3_5	SCL	O	I	H	IIC CLOCK OUTPUT

### EPM3032A (Programmable Logic Device) (MAIN :U203)

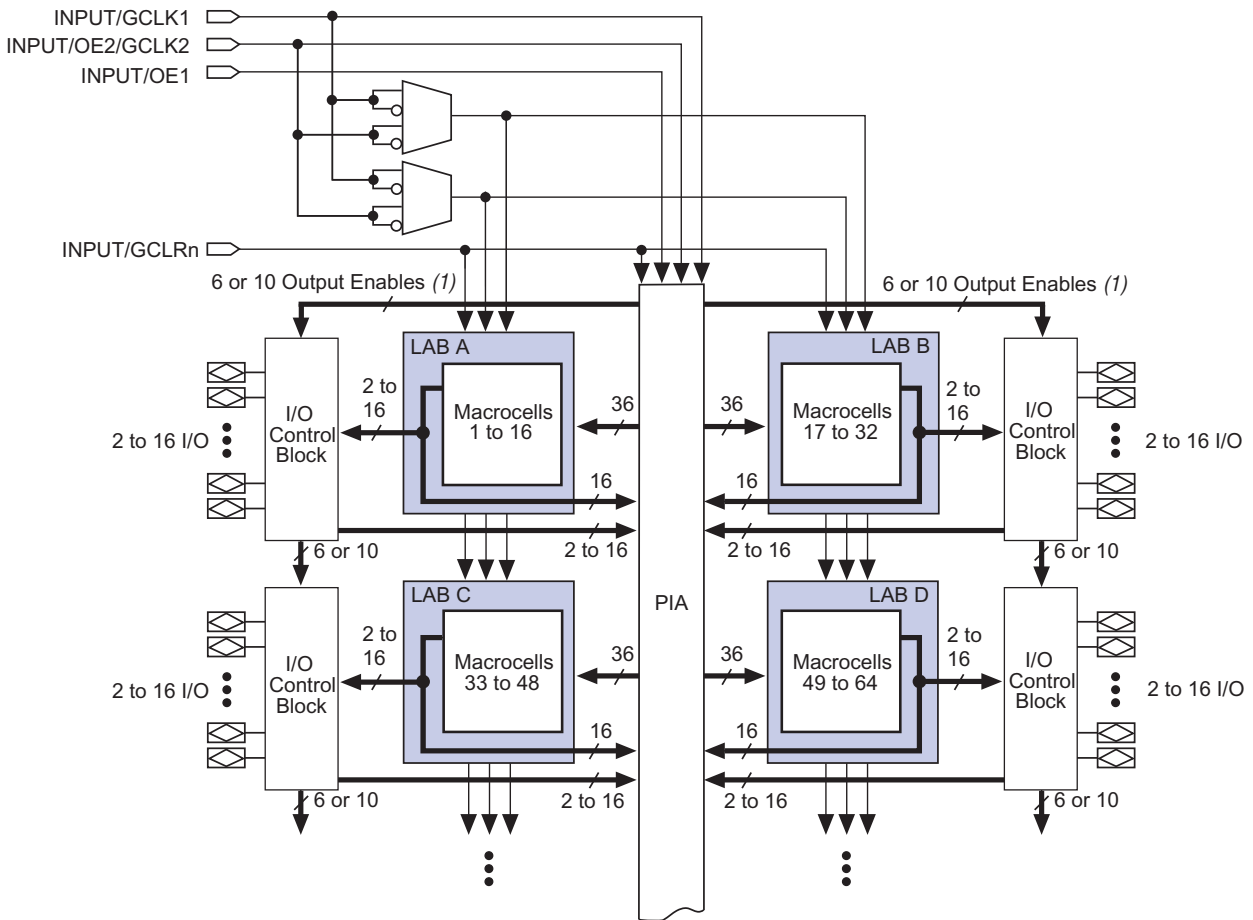

## EPM3032A Terminal Functions

Pin Name	Name/Usage	Pin No.	Dir.	I/O Standard	Voltage	User Assignment
TDI	TDI	1	input	3.3-V LVTTTL		N For PLD writing
SEL2	RESERVED_INPUT	2				SEL
NC	RESERVED_INPUT	3				NC
GNDIO	GND	4	gnd			GND
SYCL	SMLCK	5	output	3.3-V LVTTTL		Y Master Clock output
LRCK/SAR	SWCLK	6	output	3.3-V LVTTTL		Y Word Clock output
TMS	TMS	7	input	3.3-V LVTTTL		N For PLD writing
BCK/SACK	SBCLK	8	output	3.3-V LVTTTL		Y Bit Clock output
VCC	VCCIO	9	power		3.3V	Power
SDAT/SAL	SDATA	10	output	3.3-V LVTTTL		Y Audio Data output
GND	GND	11	gnd			GND
DIRINT/EMPH	EMP_FLG	12	output	3.3-V LVTTTL		Y DAIR interrupt request output
USB/CD	CD_USB	13	input	3.3-V LVTTTL		Y SA-CD&CD/USB change signal input
SA/DIR	CD_DIR	14	input	3.3-V LVTTTL		Y SA-CD&CD/DAIR change signal input
DIRMCK	DAIR_MCLK	15	input	3.3-V LVTTTL		Y DAIR Master Clock input
GNDINT	GND	16	gnd			GND
VCC	VCCINT	17	power		3.3V	Power
DIRBCK	DAIR_BCLK	18	input	3.3-V LVTTTL		Y DAIR Bit Clock input
DIRLR	DAIR_WCLK	19	input	3.3-V LVTTTL		Y DAIR Word Clock input
DIRDAT	DAIR_DATA	20	input	3.3-V LVTTTL		Y DAIR Audio Data input
SA/PCM	CD_SACD	21	input	3.3-V LVTTTL		Y CD/SA-CD change signal input
USBMCK	USB_MCLK	22	input	3.3-V LVTTTL		Y USB Master Clock input
USBSCLK	USB_BCLK	23	input	3.3-V LVTTTL		Y USB Bit Clock input
GND	GND	24	gnd			GND
USBDAT	USB_DATA	25	input	3.3-V LVTTTL		Y USB Audio Data input
TCK	TCK	26	input	3.3-V LVTTTL		N For PLD writing
USBLR	USB_WCLK	27	input	3.3-V LVTTTL		Y USB Word Clock input
MCLK	CD_MCLK	28	input	3.3-V LVTTTL		Y SA-CD Module Master Clock input
VCC	VCCIO	29	power		3.3V	Power
GND	GND	30	gnd			GND
MLRCK	CD_WCLK	31	input	3.3-V LVTTTL		Y SA-CD Module Word Clock input
TDO	TDO	32	output	3.3-V LVTTTL		N For PLD writing
MSDAT	CD_DATA	33	input	3.3-V LVTTTL		Y SA-CD Module Audio Data input
MDATR	MOD_DATAR	34	input	3.3-V LVTTTL		Y SA-CD Module DSD Rch Data input
MBCL	CD_BCLK	35	input	3.3-V LVTTTL		Y SA-CD Module Bit Clock input
GND	GND	36	gnd			GND
CS		37				D_CS2, SA-CD Module K001 PWB
SO		38				D_SO, SA-CD Module K001 PWB
NC		39				NC
SC		40				D_SCLK, SA-CD Module K001 PWB
VCC	VCCINT	41	power		3.3V	Power
NC	RESERVED_INPUT	42				NC
DIRINT_IN	DIR_INT_I	43	input	3.3-V LVTTTL		Y DAIR interrupt request output
SEL1	RESERVED_INPUT	44				SEL

## TE7022L (MAIN :U632)

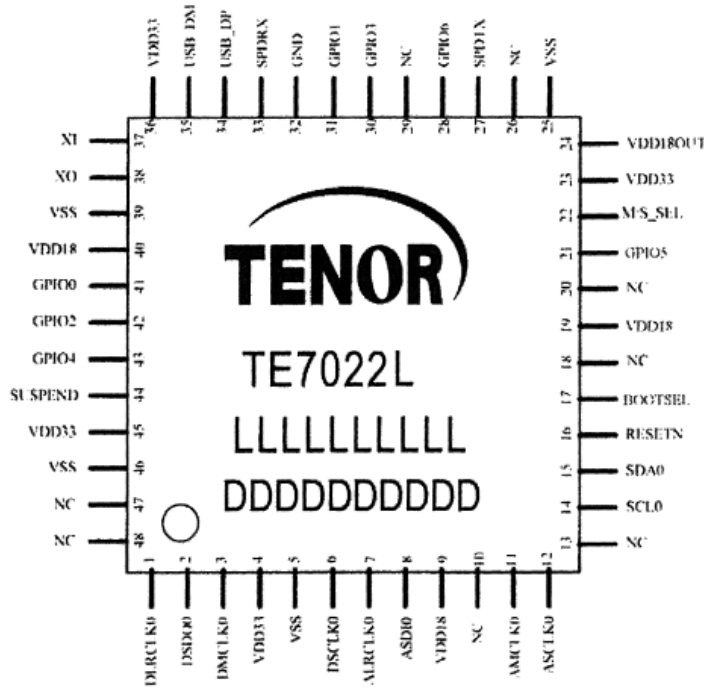

### TE7022L Pin Descriptions

Pin	Pin Name	I/O	Pin Descriptions
1	DLRCLK0	I/O	I2S-Out L/R Clock: Output in master mode, Input in slave mode
2	DSDO0	O	I2S-Out Data
3	DMCLK0	O	I2S-Out Mater Clock
4	VDD33	I	Power 3.3V supply
5	VSS	-	Ground
6	DSCLK0	I/O	I2S-Out Bit Clock, Output in master mode, Input in slave mode
7	ALRCLK0	I/O	I2S-In L/R Clock, Output in master mode, Input in slave mode
8	ASDI0	I	I2S-In Data
9	VDD18	I	Core Power 1.8V supply
10	TEST	I/O	For FT test only
11	AMCLK0	O	I2S-In Master Clock
12	ASCLK0	I/O	I2S Input Bit Clock, Output in master mode, Input in slave mode
13	NC	-	NC
14	SCL0	I/O	2-Wire Clock
15	SDA0	I/O	2-Wire Data
16	RESETN	I	Reset pin. Active "Low" , Internal Pull-up
17	BOOTSEL	I	Strapping Pin for Boot from External EEPROM or internal ROM Pull-down is boot form internal ROM. ( Please refer to "Chapter 5.5 External EEPROM Support")
18	NC	-	NC
19	VDD18	I	Core Power 1.8V supply

## TE7022L Pin Descriptions

20	NC	-	NC
21	GPIO5	I/O	GPIO5
22	M/S_SEL	I	Power on strapping for I2S(In/Out) Master/Slave select pin. Pull-up is Slave mode.
23	VDD33	I	Power 3.3V supply
24	VDD18OUT	O	1.8V output
25	VSS	-	GND
26	TEST	I/O	For FT test only
27	SPD TX	O	S/PDIF TX
28	GPIO6	I/O	GPIO6
29	NC	-	NC
30	GPIO3	I/O	GPIO3
31	GPIO1	I/O	GPIO1
32	VSS	-	GND
33	SPDRX	I	S/PDIF RX
34	USB_DP	I/O	USB D+
35	USB_DM	I/O	USB D-
36	VDD33	I	Power 3.3V
37	XI	I	X'tal Clock
38	XO	O	X'tal Clock
39	VSS	-	GND
40	VDD18	I	Core Power 1.8V supply
41	GPIO0	I/O	GPIO0
42	GPIO2	I/O	GPIO2
43	GPIO4	I/O	<ol style="list-style-type: none"> <li>1. For internal ROM is report for HID "Scan Next Track" function</li> <li>2. GPIO4 becomes an input only pin if external ROM descriptor is used. It will reflect the board power status. <ol style="list-style-type: none"> <li>a. If the system is currently self-powered, it should feed a 1 to GPIO4.</li> <li>b. If the system is currently bus-powered, it should feed a 0 to GPIO4.</li> </ol> </li> </ol> <p><b>Note that the "Scan Next Track" in HID report in this scenario should be removed.</b></p>
44	SUSPEND	O	When USB in Suspend mode: '1', USB in normal mode: '0'.
45	VDD33	I	Power 3.3V
46	VSS	-	GND
47	NC	-	NC
48	NC	-	NC

# uPD63901GJ (MAIN :U501)

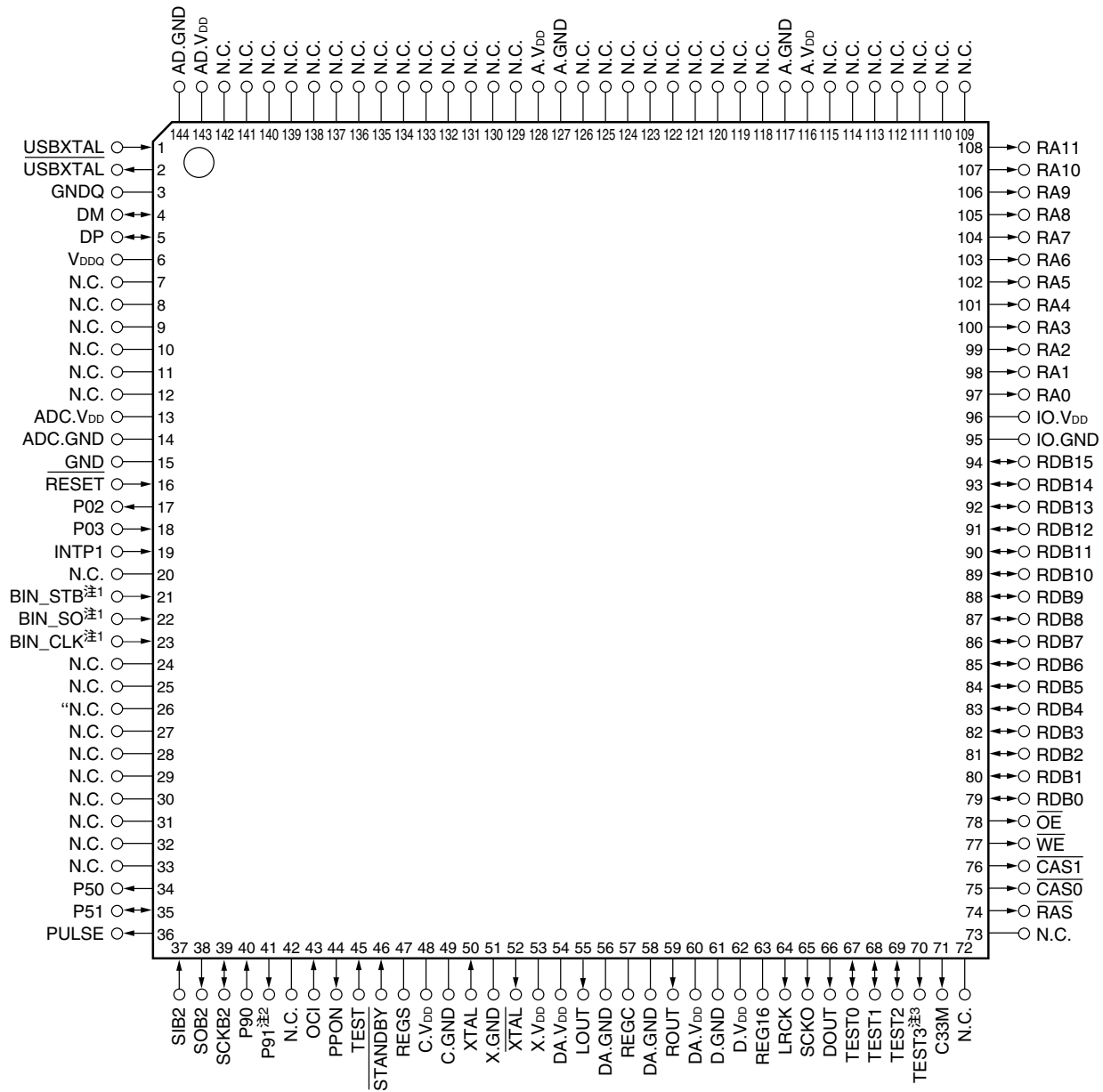

## uPD63901GJ Terminal Functions

Pin No.	Pin Name	Pin Description	I/O	Initial	Standby
1	USBXTAL	48MHz	I	-	-
2	USBXTAL	48MHz	O	-	-
3	GNDQ	USB GND	-	-	-
4	DM	USB DATA -	I/O	High-Z	High-Z
5	DP	USB DATA +	I/O	High-Z	High-Z
6	VDDQ	USB VDD	-	-	-
7	N.C.	-	-	-	-
8	N.C.	-	-	-	-
9	N.C.	-	-	-	-
10	N.C.	-	-	-	-
11	N.C.	-	-	-	-
12	N.C.	-	-	-	-
13	ADC.VDD	Analog VDD	-	-	-
14	ADC.GND	Analog GND	-	-	-
15	GND	-	-	-	-



Pin No.	Pin Name	Pin Description	I/O	Initial	Standby
16	RESET	Control Engine Reset	I	-	-
17	P02	Standby signal output	O	High-Z	Low
18	P03	Standby signal input	I	High-Z	-
19	INTP1	Command RTS input	I	High-Z	-
20	N.C.	-	-	-	-
21	BIN_STB	Download strobe input	I	High-Z	-
22	BIN_SO	Download Data input	I	High-Z	-
23	BIN_CLK	Download Clock	I	High-Z	-
24	N.C.	-	-	-	-
25	N.C.	-	-	-	-
26	N.C.	-	-	-	-
27	N.C.	-	-	-	-
28	N.C.	-	-	-	-
29	N.C.	-	-	-	-
30	N.C.	-	-	-	-
31	N.C.	-	-	-	-
32	N.C.	-	-	-	-
33	N.C.	-	-	-	-
34	P50	CTS output	O	High-Z	Low
35	P51	General port 51	I/O	High-Z	-
36	PULSE	Operate Pulse	O	High-Z	Low
37	SIB2	Command Serial Data input	I	High-Z	-
38	SOB2	Command Serial Data output	I/O	High-Z	-
39	SCKB2	Command Serial Clock	I/O	High-Z	-
40	P90	MSB/LSB Select	I	High-Z	-
41	P91	Asynchronous error output	O	High-Z	Low
42	N.C.	-	-	-	-
43	OCI	USB over current input	I	High-Z	High-Z
44	PPON	USB over current control	O	Low	Low
45	TEST	Test port	I	-	-
46	STANDBY	Standby input	-	-	-
47	REGS	Standby capacitor	-	-	-
48	C.VDD	Control engine core VDD	-	-	-
49	C.GND	Control engine core GND	-	-	-
50	XTAL	16.9344MHz	I	-	-
51	X.GND	OSC GND	-	-	-
52	XTAL	16.9344MHz	O	-	-
53	X.VDD	OSC VDD	-	-	-
54	DA.VDD	DAC VDD	-	-	-
55	LOUT	Analog audio Lch	O	-	-
56	DA.GND	DAC GND	-	-	-
57	REGC	Band gap Capacitor	-	-	-
58	DA.GND	DAC GND	-	-	-
59	ROUT	Analog audio Rch	O	-	-
60	DA.VDD	DAC VDD	-	-	-
61	D.GND	Digital GND	-	-	-
62	D.VDD	Digital VDD	-	-	-
63	REG16	1.6V VDD capacitor	-	-	-
64	LRCK	Audio LR clock	O	Low	Low
65	SCKO	Audio serial clock	O	Low	Low
66	DOUT	Audio data	O	Low	Low
67	TEST0	Test port	I/O	Low	Low

Pin No.	Pin Name	Pin Description	I/O	Initial	Standby
68	TEST1	Test port	I/O	Low	Low
69	TEST2	Test port	I/O	Low	Low
70	TEST3	Test port	O	Low	Low
71	C33M	DRAM CLOCK	O	Low	Low
72	N.C.	-	-	-	-
73	N.C.	-	-	-	-
74	$\overline{\text{RAS}}$	DRAM $\overline{\text{RAS}}$ output	O	Low	Low
75	$\overline{\text{CAS0}}$	DRAM Lower $\overline{\text{CAS}}$ output	O	Low	Low
76	$\overline{\text{CAS1}}$	DRAM Upper $\overline{\text{CAS}}$ output	O	Low	Low
77	$\overline{\text{WE}}$	DRAM $\overline{\text{WE}}$ output	O	Low	Low
78	$\overline{\text{OE}}$	DRAM $\overline{\text{OE}}$ output	O	Low	Low
79	RDB0	DRAM Data0 input	I/O	High-Z	High-Z
80	RDB1	DRAM Data1 input	I/O	High-Z	High-Z
81	RDB2	DRAM Data2 input	I/O	High-Z	High-Z
82	RDB3	DRAM Data3 input	I/O	High-Z	High-Z
83	RDB4	DRAM Data4 input	I/O	High-Z	High-Z
84	RDB5	DRAM Data5 input	I/O	High-Z	High-Z
85	RDB6	DRAM Data6 input	I/O	High-Z	High-Z
86	RDB7	DRAM Data7 input	I/O	High-Z	High-Z
87	RDB8	DRAM Data8 input	I/O	High-Z	High-Z
88	RDB9	DRAM Data9 input	I/O	High-Z	High-Z
89	RDB10	DRAM Data10 input	I/O	High-Z	High-Z
90	RDB11	DRAM Data11 input	I/O	High-Z	High-Z
91	RDB12	DRAM Data12 input	I/O	High-Z	High-Z
92	RDB13	DRAM Data13 input	I/O	High-Z	High-Z
93	RDB14	DRAM Data14 input	I/O	High-Z	High-Z
94	RDB15	DRAM Data15 input	I/O	High-Z	High-Z
95	IO.GND	I/O GND	-	-	-
96	IO.V <sub>DD</sub>	I/O VDD	-	-	-
97	RA0	DRAM Address0 output	O	Low	Low
98	RA1	DRAM Address1 output	O	Low	Low
99	RA2	DRAM Address2 output	O	Low	Low
100	RA3	DRAM Address3 output	O	Low	Low
101	RA4	DRAM Address4 output	O	Low	Low
102	RA5	DRAM Address5 output	O	Low	Low
103	RA6	DRAM Address6 output	O	Low	Low
104	RA7	DRAM Address7 output	O	Low	Low
105	RA8	DRAM Address8 output	O	Low	Low
106	RA9	DRAM Address9 output	O	Low	Low
107	RA10	DRAM Address10 output	O	Low	Low
108	RA11	DRAM Address11 output	O	Low	Low
109	N.C.	-	-	-	-
110	N.C.	-	-	-	-
111	N.C.	-	-	-	-
112	N.C.	-	-	-	-
113	N.C.	-	-	-	-
114	N.C.	-	-	-	-
115	N.C.	-	-	-	-
116	A.V <sub>DD</sub>	Analog VDD	-	-	-
117	A.GND	Analog GND	-	-	-
118	N.C.	-	-	-	-
119	N.C.	-	-	-	-

Pin No.	Pin Name	Pin Description	I/O	Initial	Standby
120	N.C.	-	-	-	-
121	N.C.	-	-	-	-
122	N.C.	-	-	-	-
123	N.C.	-	-	-	-
124	N.C.	-	-	-	-
125	N.C.	-	-	-	-
126	N.C.	-	-	-	-
127	A.GND	Analog GND	-	-	-
128	A.V <sup>DD</sup>	Analog VDD	-	-	-
129	N.C.	-	-	-	-
130	N.C.	-	-	-	-
131	N.C.	-	-	-	-
132	N.C.	-	-	-	-
133	N.C.	-	-	-	-
134	N.C.	-	-	-	-
135	N.C.	-	-	-	-
136	N.C.	-	-	-	-
137	N.C.	-	-	-	-
138	N.C.	-	-	-	-
139	N.C.	-	-	-	-
140	N.C.	-	-	-	-
141	N.C.	-	-	-	-
142	N.C.	-	-	-	-
143	A.V <sup>DD</sup>	Analog VDD	-	-	-
144	A.GND	Analog GND	-	-	-

## 2.FL DISPLAY

### FLD (13-BT-237INK) (FRONT : Z0701)

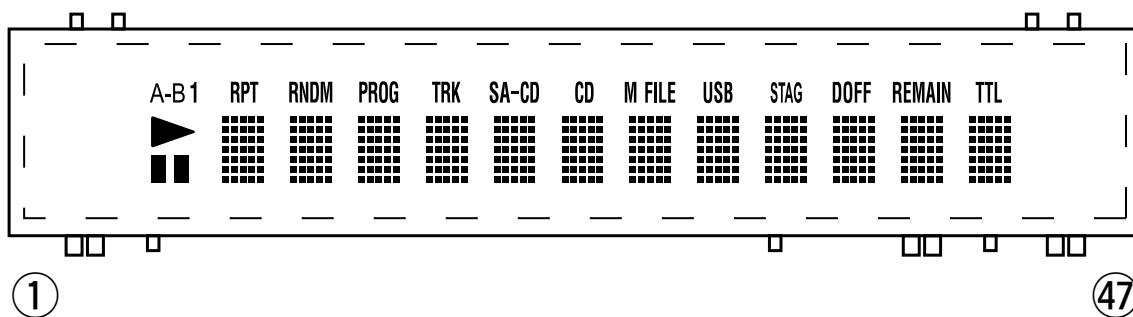

### PIN CONNECTION

PIN NO.	1	2	3	4	5	6	7	8	9	10	11	12	13	14	15	16	17	18	19	20	21	22	23	24	25	26	27	28	29	30	31	32	33	34	35	36	37	38	39	40	41	42	43	44	45	46	47							
CONNECTION	F	F	N	N	N	N	N	N	N	N	N	N	N	N	N	N	N	N	N	N	N	N	N	N	N	N	N	N	N	N	N	N	N	N	N	N	N	N	N	N	N	N	N	N	N	N	N	N	N	N	N	N	N	
	11	P	P	P	P	P	P	P	P	P	P	P	P	P	P	P	P	P	P	P	P	P	P	P	P	P	P	P	P	P	P	P	P	P	P	P	P	P	P	P	P	P	P	P	P	P	P	P	P	P	P	P	P	P

- NOTE
- 1) F1, F2 --- Filament
  - 2) NP ----- No pin
  - 3) DL ----- Datum Line
  - 4) LGND ----- Logic GND pin
  - 5) PGND ----- Power GND pin
  - 6) VH ----- High Voltage Supply pin
  - 7) VDD ----- Logic Voltage Supply pin
  - 8) CP ----- Shift Register Clock
  - 9) DA ----- Serial Data Input
  - 10) 1.5MAX is applied to all the leads inside A area.  
0.8MAX is applied to all the leads inside B area.
  - 11) TSA, B ---- Test pin
  - 12) CS ----- Chip Select Input pin
  - 13) OSC ----- Pin for self-oscillation
  - 14) RESET ---- Reset Input
  - 15) Solder composition is Sn-3Ag-0.5Cu. (unit in mm)

### GRID ASSIGNMENT

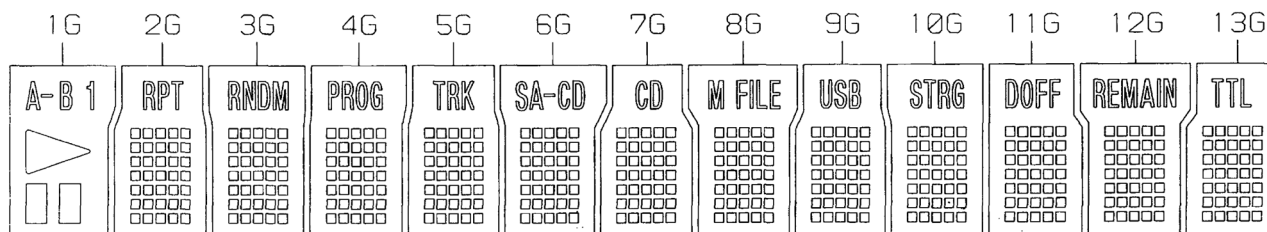

(2G~13G)

ANODE CONNECTION

	1G	2G	3G	4G	5G	6G	7G	8G	9G	10G	11G	12G	13G
AD1	A-	RPT	RNDM	PROG	TRK	SA-CD	CD	M FILE	USB	STRG	DOFF	REMAIN	TTL
D0	B	1-1	1-1	1-1	1-1	1-1	1-1	1-1	1-1	1-1	1-1	1-1	1-1
D1	1	2-1	2-1	2-1	2-1	2-1	2-1	2-1	2-1	2-1	2-1	2-1	2-1
D2	▷	3-1	3-1	3-1	3-1	3-1	3-1	3-1	3-1	3-1	3-1	3-1	3-1
D3	□□	4-1	4-1	4-1	4-1	4-1	4-1	4-1	4-1	4-1	4-1	4-1	4-1
D4	-	5-1	5-1	5-1	5-1	5-1	5-1	5-1	5-1	5-1	5-1	5-1	5-1
D5	-	1-2	1-2	1-2	1-2	1-2	1-2	1-2	1-2	1-2	1-2	1-2	1-2
D6	-	2-2	2-2	2-2	2-2	2-2	2-2	2-2	2-2	2-2	2-2	2-2	2-2
D7	-	3-2	3-2	3-2	3-2	3-2	3-2	3-2	3-2	3-2	3-2	3-2	3-2
D8	-	4-2	4-2	4-2	4-2	4-2	4-2	4-2	4-2	4-2	4-2	4-2	4-2
D9	-	5-2	5-2	5-2	5-2	5-2	5-2	5-2	5-2	5-2	5-2	5-2	5-2
D10	-	1-3	1-3	1-3	1-3	1-3	1-3	1-3	1-3	1-3	1-3	1-3	1-3
D11	-	2-3	2-3	2-3	2-3	2-3	2-3	2-3	2-3	2-3	2-3	2-3	2-3
D12	-	3-3	3-3	3-3	3-3	3-3	3-3	3-3	3-3	3-3	3-3	3-3	3-3
D13	-	4-3	4-3	4-3	4-3	4-3	4-3	4-3	4-3	4-3	4-3	4-3	4-3
D14	-	5-3	5-3	5-3	5-3	5-3	5-3	5-3	5-3	5-3	5-3	5-3	5-3
D15	-	1-4	1-4	1-4	1-4	1-4	1-4	1-4	1-4	1-4	1-4	1-4	1-4
D16	-	2-4	2-4	2-4	2-4	2-4	2-4	2-4	2-4	2-4	2-4	2-4	2-4
D17	-	3-4	3-4	3-4	3-4	3-4	3-4	3-4	3-4	3-4	3-4	3-4	3-4
D18	-	4-4	4-4	4-4	4-4	4-4	4-4	4-4	4-4	4-4	4-4	4-4	4-4
D19	-	5-4	5-4	5-4	5-4	5-4	5-4	5-4	5-4	5-4	5-4	5-4	5-4
D20	-	1-5	1-5	1-5	1-5	1-5	1-5	1-5	1-5	1-5	1-5	1-5	1-5
D21	-	2-5	2-5	2-5	2-5	2-5	2-5	2-5	2-5	2-5	2-5	2-5	2-5
D22	-	3-5	3-5	3-5	3-5	3-5	3-5	3-5	3-5	3-5	3-5	3-5	3-5
D23	-	4-5	4-5	4-5	4-5	4-5	4-5	4-5	4-5	4-5	4-5	4-5	4-5
D24	-	5-5	5-5	5-5	5-5	5-5	5-5	5-5	5-5	5-5	5-5	5-5	5-5
D25	-	1-6	1-6	1-6	1-6	1-6	1-6	1-6	1-6	1-6	1-6	1-6	1-6
D26	-	2-6	2-6	2-6	2-6	2-6	2-6	2-6	2-6	2-6	2-6	2-6	2-6
D27	-	3-6	3-6	3-6	3-6	3-6	3-6	3-6	3-6	3-6	3-6	3-6	3-6
D28	-	4-6	4-6	4-6	4-6	4-6	4-6	4-6	4-6	4-6	4-6	4-6	4-6
D29	-	5-6	5-6	5-6	5-6	5-6	5-6	5-6	5-6	5-6	5-6	5-6	5-6
D30	-	1-7	1-7	1-7	1-7	1-7	1-7	1-7	1-7	1-7	1-7	1-7	1-7
D31	-	2-7	2-7	2-7	2-7	2-7	2-7	2-7	2-7	2-7	2-7	2-7	2-7
D32	-	3-7	3-7	3-7	3-7	3-7	3-7	3-7	3-7	3-7	3-7	3-7	3-7
D33	-	4-7	4-7	4-7	4-7	4-7	4-7	4-7	4-7	4-7	4-7	4-7	4-7
D34	-	5-7	5-7	5-7	5-7	5-7	5-7	5-7	5-7	5-7	5-7	5-7	5-7

# PARTS LIST OF P.W.B. UNIT

\* Parts for which "nsp" is indicated on this table cannot be supplied.

\* The parts listed below are for maintenance only, might differ from the parts used in the unit in appearances or dimensions.

**Note:** The symbols in the column "Remarks" indicate the following destinations.

U : North America model  
B : Black model

N : Europe model  
SG : Silver gold model

K : China model

## FRONT PWB ASSY

Ref. No.	Part No.	Part Name	Remarks	Q'ty	New
<b>SEMICONDUCTORS GROUP</b>					
D0551	00MHZ20018050	1SS302 (TE85L F) (TOSHIBA)			
D0552-0554	251310004507S	CG0603MLC-12LE			
D0701	00D3939607908	SLR342VC(TB7)			
D0751	00D3939607908	SLR342VC(TB7)			
U0701	231310009508S	PQ033DNA1ZPH			
Q0701	00D2690192902	KRC102S-RTK/P (10K-10K)			
Q0702	00D2690184907	KRA102S-RTK/P (10K-10K)			
Q0751	00D2690184907	KRA102S-RTK/P (10K-10K)			
<b>RESISTORS GROUP</b>					
R0551	nsp	RM73B--222JT +1608			
R0701	nsp	RM73B--102JT +1608			
R0702-0705	nsp	RM73B--0R0KT +1608			
R0706	nsp	RM73B--333JT +1608			
R0707,0708	nsp	RM73B--221JT +1608			
R0709	nsp	RM73B--103JT +1608			
R0710	nsp	RM73B--103JT +1608			
R0721,0722	nsp	RM73B--102JT +1608			
R0723,0724	nsp	RM73B--331JT (1608) +1608			
R0725,0726	nsp	RM73B--681JT +1608			
R0727,0728	nsp	RM73B--182JT +1608			
R0751	nsp	RM73B--103JT +1608			
R0752	nsp	RM73B--331JT (1608) +1608			
R0753	nsp	RM73B--103JT +1608			
V0451	00D2115646001	V092Q20FA103 (METAL)			
<b>CAPACITORS GROUP</b>					
C0451,0452	nsp	CC73CH1H102JT +1608			
C0453	nsp	C1608X7R1H104K (0.1UF 50V)			
C0454	nsp	CC73CH1H102JT +1608			
C0551,0552	nsp	C1608X7R1H104K (0.1UF 50V)			
C0553	00D2544299964	CE04W1C470MT(SRE)			
C0554	nsp	C1608X7R1H104K (0.1UF 50V)			
C0701-0704	nsp	C1608X7R1H104K (0.1UF 50V)			
C0705	00D2544299964	CE04W1C470MT(SRE)			
C0710	00D2544304927	CE04W1V4R7MT(SRE)			
C0711	nsp	C1608X7R1H104K (0.1UF 50V)			
C0712	00D2544299964	CE04W1C470MT(SRE)			
C0713	nsp	C1608X7R1H104K (0.1UF 50V)			

Ref. No.	Part No.	Part Name	Remarks	Q'ty	New
C0714	00D2570507976	CC73CH1H331JT +1608			
C0715,0716	nsp	C1608X7R1H104K (0.1UF 50V)			
C0718,0719	nsp	C1608X7R1H104K (0.1UF 50V)			
C0720,0721	00D2544299964	CE04W1C470MT(SRE)			
C0751,0752	nsp	C1608X7R1H104K (0.1UF 50V)			
<b>OTHERS PARTS GROUP</b>					
L0451,0452	nsp	RM73B--0R0KT +1608			
N0451	nsp	B8B-PH-K-S (LF)(SN)			
N0551	nsp	6P FFC BASE(9610SA)			
N0552	nsp	S3B-PH-K-S (LF)(SN)			
N0701	nsp	20P FFC BASE(9610SB)			
N0702	nsp	S4B-PH-K-S (LF)(SN)			
N0751	nsp	S4B-PH-K-S (LF)(SN)			
S0721-0727	662010001408S	SKHVBF F0052759M			
S0751	662010001408S	SKHVBF F0052759M			
K0451	00MYJ01005170	JY-6313_01-030 6.4D PHONE JACK			
K0551	00D2051381006	USB CONNECTOR			
Z0701	00MHQ31203410	13-BT-237INK			
Z0702	00MHW10004210	RPM6936-V4 (IR SENSOR)			
Z0703,0704	nsp	HOLDER SA7003 33AK			
Z0751	nsp	STYLE PIN			

# MAIN PWB ASSY

	Ref. No.	Part No.	Part Name	Remarks	Q'ty	New
<b>SEMICONDUCTORS GROUP</b>						
	D0301-0316	00D2760401905	1SS133T77 (TAPE)			
	D0401-0404	00D2760401905	1SS133T77 (TAPE)			
⚠	D0451,0452	00D2760704903	1SR35-400A(T93X)			
	D0453	00MHZ3047100Y	MA8047-M 4.7V			
⚠	D0454	00D2760704903	1SR35-400A(T93X)			
	D0455	00D2760794900	KDS160-RTK/P			
	D0456	00D2760704903	1SR35-400A(T93X)			
	D0457,0458	00D2760794900	KDS160-RTK/P			
	D0481,0482	00D2760794900	KDS160-RTK/P			
	D0631-0633	251310004507S	CG0603MLC-12LE			
	D0634	00MHZ2001805Y	1SS302 (TE85L F) (TOSHIBA)			
	D0681	00MHZ2001805Y	1SS302 (TE85L F) (TOSHIBA)			
	D0801-0803	00D2760704903	1SR35-400A(T93X)			
	D0804	00D2760798935	UDZS20B-TE17			
⚠	D0811	203010001007S	D3SB60			
⚠	D0812-0816	00MHD20055101	!SHOTTKY 11EQS10 1A 100V			
⚠	D0821-0824	00MHD20055101	!SHOTTKY 11EQS10 1A 100V			
⚠	D0831	00MHD20055101	!SHOTTKY 11EQS10 1A 100V			
⚠	D0832	00D2760704903	1SR35-400A(T93X)			
⚠	D0833	00D2760683985	UDZS11B-TE17			
⚠	D0834	00D2760683998	UDZS16B-TE17 +C			
⚠	D0835	00MHD20055101	!SHOTTKY 11EQS10 1A 100V			
	D0841	00MHZ3047100Y	MA8047-M 4.7V			
	D0842	00MHZ3047100Y	MA8047-M 4.7V			
⚠	D0851	00MHD20055101	!SHOTTKY 11EQS10 1A 100V			
⚠	D0852	00MHD20055101	!SHOTTKY 11EQS10 1A 100V			
⚠	D0853	00MHD20055101	!SHOTTKY 11EQS10 1A 100V			
⚠	D0854	00MHD20055101	!SHOTTKY 11EQS10 1A 100V			
	D0855	00D2760401905	1SS133T77 (TAPE)			
	D0856	00D2760407912	HZ6A-1LTD(TAPE)			
	D0857	00D2760407912	HZ6A-1LTD(TAPE)			
	D0858	00D2760401905	1SS133T77 (TAPE)			
⚠	D0881	00D2760704903	1SR35-400A(T93X)			
	D0882	00D2760704903	1SR35-400A(T93X)			
	D0883	00D2760704903	1SR35-400A(T93X)			
⚠	D0884	00D2760704903	1SR35-400A(T93X)			
⚠	D0885	00D2760704903	1SR35-400A(T93X)			
⚠	D0886	00D2760704903	1SR35-400A(T93X)			
	D0887	00D2760704903	1SR35-400A(T93X)			
	D0901	00D2760794900	KDS160-RTK/P			
	U0101	00D2623388903	AT24C04AN-10SU-1.8-SL383			
	U0102	239810049604S	R5F212CCSNFP			*
	U0103	00D2623410907	TC74VHCT08AFT			
	U0151	236710076509S	MF1341S2164 IPOD COPROCESSOR 2.0B CLASS6			
	U0181	00MHC1022921Z	BD4727G 2.7V RESET IC			
	U0182	232710014509S	BD7931F-E2			
⚠	U0201	231310009508S	PQ033DNA1ZPH			
⚠	U0202	00D2630809006	NJM7805FA(S)			
	U0203	236710030619S	EPM3032ATC44-10NSA8004			

**NOTE :**  
 When update Firmware,  
 please confirm a last  
 version in SDI.  
 Use the service board  
 after updating it.



Ref. No.	Part No.	Part Name	Remarks	Q'ty	New
U0204	00MHC10020880	CS4398-CZZR/D			
U0401	00MHC10111090	DUAL LOW NOISE OP-AMP NJM2114D			
U0501	239810050604S	UPD63901-501			*
U0601	00D2623447909	TC4053BFT			
U0632	239810048601S	TE7022L			*
U0633					
U0634	00D2623449004	LC89057W-VF4A			
U0636	00MHC10433990	AT24C08BN-SH-T			
U0637	236810074502S	CS2100**-CZZR			
△ U0811	00MHC3190532F	!PQ05RD21 5V 2A			
△ U0821	00D2630810008	NJM7808FA(S)			
△ U0822	00D2630809006	NJM7805FA(S)			
△ U0823	231310009508S	PQ033DNA1ZPH			
△ U0831	00D2630801004	NJM7812FA(S)			
△ U0881	00D2631240907	BA33B00FP-E2			
U0921	00D2623077900	TC74VHCU04FT +REF			
Q0101	00D2690192902	KRC102S-RTK/P (10K-10K)			
Q0102	00D2690192902	KRC102S-RTK/P (10K-10K)			
Q0103	00D2690184907	KRA102S-RTK/P (10K-10K)			
Q0181	00D2690184907	KRA102S-RTK/P (10K-10K)			
Q0182	00D2690184907	KRA102S-RTK/P (10K-10K)			
Q0183	00D2690192902	KRC102S-RTK/P (10K-10K)			
Q0184	00D2690192902	KRC102S-RTK/P (10K-10K)			
Q0186	00D2690192902	KRC102S-RTK/P (10K-10K)			
Q0201	00D2690192902	KRC102S-RTK/P (10K-10K)			
Q0202	00D2690192902	KRC102S-RTK/P (10K-10K)			
Q0301	00MHF203691B1	2SK369 BL VGDS-40V PD0.4W			
Q0302	00MHF203691B1	2SK369 BL VGDS-40V PD0.4W			
Q0303	00D2730198921	2SC1815(GR)TPE2			
Q0304	00D2730198921	2SC1815(GR)TPE2			
Q0305	00MHF203691B1	2SK369 BL VGDS-40V PD0.4W			
Q0306	00MHF203691B1	2SK369 BL VGDS-40V PD0.4W			
Q0307	00D2710102924	2SA1015(GR)TPE2			
Q0308	00D2710102924	2SA1015(GR)TPE2			
Q0309	00D2730198921	2SC1815(GR)TPE2			
Q0310	00D2730198921	2SC1815(GR)TPE2			
Q0311	00D2710102924	2SA1015(GR)TPE2			
Q0312	00D2710102924	2SA1015(GR)TPE2			
Q0313	00D2730198921	2SC1815(GR)TPE2			
Q0314	00D2730198921	2SC1815(GR)TPE2			
Q0315	00D2710102924	2SA1015(GR)TPE2			
Q0316	00D2710102924	2SA1015(GR)TPE2			
Q0317	00D2730198921	2SC1815(GR)TPE2			
Q0318	00D2730198921	2SC1815(GR)TPE2			
Q0319	00D2710102924	2SA1015(GR)TPE2			
Q0320	00D2710102924	2SA1015(GR)TPE2			
Q0321	00D2730198921	2SC1815(GR)TPE2			
Q0322	00D2730198921	2SC1815(GR)TPE2			
Q0323	00D2730198921	2SC1815(GR)TPE2			
Q0324	00D2730198921	2SC1815(GR)TPE2			
Q0325	00D2710102924	2SA1015(GR)TPE2			

	Ref. No.	Part No.	Part Name	Remarks	Q'ty	New
	Q0326	00D2710102924	2SA1015(GR)TPE2			
	Q0401	00D2730198921	2SC1815(GR)TPE2			
	Q0402	00D2730198921	2SC1815(GR)TPE2			
	Q0403	00D2710102924	2SA1015(GR)TPE2			
	Q0404	00D2710102924	2SA1015(GR)TPE2			
	Q0451	00D2730198921	2SC1815(GR)TPE2			
	Q0452	00D2730198921	2SC1815(GR)TPE2			
	Q0453	00D2690088906	DTC114TKT96 +C			
	Q0454	00D2690088906	DTC114TKT96 +C			
	Q0456	00D2710102924	2SA1015(GR)TPE2			
	Q0457	00D2690088906	DTC114TKT96 +C			
	Q0481	00D2730460905	KTC2875-B-RTK/P			
	Q0482	00D2730460905	KTC2875-B-RTK/P			
	Q0483	00D2730460905	KTC2875-B-RTK/P			
	Q0484	00D2730460905	KTC2875-B-RTK/P			
	Q0485	00D2730460905	KTC2875-B-RTK/P			
	Q0486	00D2730460905	KTC2875-B-RTK/P			
	Q0487	00D2730460905	KTC2875-B-RTK/P			
	Q0488	00D2730460905	KTC2875-B-RTK/P			
	Q0501	00D2690192902	KRC102S-RTK/P (10K-10K)			
	Q0631	00D2690184907	KRA102S-RTK/P (10K-10K)			
	Q0632	00D2690088906	DTC114TKT96 +C			
	Q0801	00D2730198921	2SC1815(GR)TPE2			
	Q0802	00D2690088906	DTC114TKT96 +C			
△	Q0831	00D2690088906	DTC114TKT96 +C			
	Q0832	00D2710102924	2SA1015(GR)TPE2			
	Q0833	00D2690088906	DTC114TKT96 +C			
	Q0851	00MHF202461C1	2SK246 (GR)			
	Q0852	00MHF202461C1	2SK246 (GR)			
△	Q0853	00MHT41415100	TRANSISTOR 2SD1415			
	Q0855	00D2730198921	2SC1815(GR)TPE2			
△	Q0854	00MHT21020100	2SB1020			
	Q0856	00D2710102924	2SA1015(GR)TPE2			
	Q0881	00D2730198921	2SC1815(GR)TPE2			
	Q0921	00D2690088906	DTC114TKT96 +C			
	Q0922	00D2690184907	KRA102S-RTK/P (10K-10K)			
	Q0923	00D2690184907	KRA102S-RTK/P (10K-10K)			
<b>RESISTORS GROUP</b>						
	R0101	nsp	RM73B--103JT +1608			
	R0102	nsp	RM73B--103JT +1608			
	R0103	nsp	RM73B--220JT +1608			
	R0104	nsp	RM73B--220JT +1608			
	R0106	nsp	RM73B--220JT +1608			
	R0108	nsp	RM73B--220JT +1608			
	R0110	nsp	RM73B--220JT +1608			
	R0112	nsp	RM73B--220JT +1608			
	R0113	nsp	RM73B--220JT +1608			
	R0114	nsp	RM73B--223JT +1608			
	R0115	nsp	RM73B--103JT +1608			
	R0117	nsp	RM73B--103JT +1608			

Ref. No.	Part No.	Part Name	Remarks	Q'ty	New
R0118	nsp	RM73B--103JT +1608			
R0119	nsp	RM73B--103JT +1608			
R0120	nsp	RM73B--103JT +1608			
R0121	nsp	RM73B--0R0KT +1608			
R0122	nsp	RM73B--103JT +1608			
R0123	nsp	RM73B--220JT +1608			
R0124	nsp	RM73B--104JT +1608			
R0125	nsp	RM73B--220JT +1608			
R0126	nsp	RM73B--104JT +1608			
R0127	nsp	RM73B--102JT +1608			
R0128	nsp	RM73B--222JT +1608			
R0131	nsp	RM73B--222JT +1608			
R0132	nsp	RM73B--222JT +1608			
R0133	nsp	RM73B--104JT +1608			
R0134	nsp	RM73B--103JT +1608			
R0135	nsp	RM73B--220JT +1608			
R0136	nsp	RM73B--103JT +1608			
R0137	nsp	RM73B--103JT +1608			
R0151	nsp	RM73B--104JT +1608			
R0152	nsp	RM73B--103JT +1608			
R0153	nsp	RM73B--103JT +1608			
R0155	nsp	RM73B--102JT +1608			
R0157	nsp	RM73B--220JT +1608			
R0159	nsp	RM73B--0R0KT +1608			
R0181	nsp	RM73B--222JT +1608			
R0182	nsp	RM73B--222JT +1608			
R0183	nsp	RM73B--102JT +1608			
R0184	nsp	RM73B--102JT +1608			
R0185	nsp	RM73B--472JT (1608) +1608			
R0186	nsp	RM73B--153JT +1608			
R0188	nsp	RM73B--0R0KT +1608			
R0201	nsp	RM73B--223JT +1608			
R0202	nsp	RM73B--103JT +1608			
R0203	nsp	RM73B--0R0KT +1608			
R0204	nsp	RM73B--0R0KT +1608			
R0205	nsp	RM73B--0R0KT +1608			
R0206	nsp	RM73B--0R0KT +1608			
R0207	nsp	RM73B--0R0KT +1608			
R0208	nsp	RM73B--0R0KT +1608			
R0209	nsp	RM73B--0R0KT +1608			
R0210	nsp	RM73B--0R0KT +1608			
R0211	nsp	RM73B--0R0KT +1608			
R0212	nsp	RM73B--0R0KT +1608			
R0213	nsp	RM73B--0R0KT +1608			
R0214	nsp	RM73B--0R0KT +1608			
R0215	nsp	RM73B--0R0KT +1608			
R0216	nsp	RM73B--0R0KT +1608			
R0217	nsp	RM73B--0R0KT +1608			
R0218	nsp	RM73B--0R0KT +1608			
R0219	nsp	RM73B--0R0KT +1608			
R0220	nsp	RM73B--223JT +1608			
R0221	nsp	RM73B--470JT +1608			

Ref. No.	Part No.	Part Name	Remarks	Q'ty	New
R0222	nsp	RM73B--470JT +1608			
R0223	nsp	RM73B--470JT +1608			
R0224	nsp	RM73B--470JT +1608			
R0225	nsp	RM73B--103JT +1608			
R0226	nsp	RM73B--103JT +1608			
R0227	nsp	RM73B--223JT +1608			
R0347	00MGG05100160	10 OHM +- 5% 1/6W FLAMERETARDANT			
R0348	00MGG05100160	10 OHM +- 5% 1/6W FLAMERETARDANT			
R0349	00MGG05100160	10 OHM +- 5% 1/6W FLAMERETARDANT			
R0350	00MGG05100160	10 OHM +- 5% 1/6W FLAMERETARDANT			
R0451	nsp	RM73B--122JT +1608			
R0452	nsp	RM73B--153JT +1608			
R0453	nsp	RM73B--105JT +1608			
R0454	nsp	RM73B--105JT +1608			
R0455	nsp	RM73B--224JT +1608			
R0456	nsp	RM73B--473JT +1608			
R0457	nsp	RM73B--472JT (1608) +1608			
R0458	nsp	RM73B--473JT +1608			
R0459	nsp	RM73B--473JT +1608			
R0460	nsp	RM73B--473JT +1608			
R0481	nsp	RM73B--472JT (1608) +1608			
R0482	nsp	RM73B--472JT (1608) +1608			
R0483	nsp	RM73B--104JT +1608			
R0484	nsp	RM73B--104JT +1608			
R0485	nsp	RM73B--472JT (1608) +1608			
R0486	nsp	RM73B--472JT (1608) +1608			
R0487	nsp	RM73B--472JT (1608) +1608			
R0488	nsp	RM73B--472JT (1608) +1608			
R0489	nsp	RM73B--472JT (1608) +1608			
R0490	nsp	RM73B--472JT (1608) +1608			
R0501	nsp	RM73B--105JT +1608			
R0502	nsp	RM73B--0R0KT +1608			
R0503	nsp	RM73B--220JT +1608			
R0504	nsp	RM73B--0R0KT +1608			
R0506	nsp	RM73B--220JT +1608			
R0508	nsp	RM73B--220JT +1608			
R0509	nsp	RM73B--103JT +1608			
R0510	nsp	RM73B--0R0KT +1608			
R0511	nsp	RM73B--0R0KT +1608			
R0512	nsp	RM73B--220JT +1608			
R0513	nsp	RM73B--220JT +1608			
R0514	nsp	RM73B--561JT +1608			
R0515	nsp	RM73B--0R0KT +1608			
R0516	nsp	RM73B--220JT +1608			
R0517	nsp	RM73B--220JT +1608			
R0518	nsp	RM73B--153JT +1608			
R0519	nsp	RM73B--153JT +1608			
R0520	nsp	RM73B--103JT +1608			
R0521	nsp	RM73B--220JT +1608			
R0522	nsp	RM73B--103JT +1608			
R0523	nsp	RM73B--220JT +1608			
R0524	nsp	RM73B--103JT +1608			

Ref. No.	Part No.	Part Name	Remarks	Q'ty	New
R0525	nsp	RM73B--103JT +1608			
R0601	nsp	RM73B--220JT +1608			
R0602	nsp	RM73B--220JT +1608			
R0603	nsp	RM73B--220JT +1608			
R0604	nsp	RM73B--220JT +1608			
R0605	nsp	RM73B--220JT +1608			
R0606	nsp	RM73B--220JT +1608			
R0608	nsp	RM73B--220JT +1608			
R0609	nsp	RM73B--220JT +1608			
R0610	nsp	RM73B--220JT +1608			
R0611	nsp	RM73B--220JT +1608			
R0612	nsp	RM73B--220JT +1608			
R0613	nsp	RM73B--220JT +1608			
R0614	nsp	RM73B--220JT +1608			
R0615	nsp	RM73B--220JT +1608			
R0616	nsp	RM73B--220JT +1608			
R0617	nsp	RM73B--220JT +1608			
R0618	nsp	RM73B--220JT +1608			
R0620	nsp	RM73B--220JT +1608			
R0621	nsp	RM73B--220JT +1608			
R0631	nsp	RM73B--220JT +1608			
R0632	nsp	RM73B--220JT +1608			
R0633	nsp	RM73B--220JT +1608			
R0634	nsp	RM73B--220JT +1608			
R0635	nsp	RM73B--220JT +1608			
R0640	nsp	RM73B--103JT +1608			
R0641	nsp	RM73B--221JT +1608			
R0642	nsp	RM73B--105JT +1608			
R0643	nsp	RM73B--220JT +1608			
R0644	nsp	RM73B--103JT +1608			
R0645	nsp	RM73B--103JT +1608			
R0647	nsp	RM73B--101JT +1608			
R0648	nsp	RM73B--101JT +1608			
R0649	nsp	RM73B--101JT +1608			
R0650	nsp	RM73B--0R0KT +1608			
R0651	nsp	RM73B--101JT +1608			
R0652	nsp	RM73B--0R0KT +1608			
R0653	nsp	RM73B--101JT +1608			
R0654	nsp	RM73B--101JT +1608			
R0655	nsp	RM73B--103JT +1608			
R0656	nsp	RM73B--103JT +1608			
R0657	nsp	RM73B--331JT (1608) +1608			
R0659	nsp	RM73B--223JT +1608			
R0661	nsp	RM73B--560JT +1608			
R0662	nsp	RM73B--560JT +1608			
R0663	nsp	RM73B--103JT +1608			
R0664	nsp	RM73B--101JT +1608			
R0665	nsp	RM73B--560JT +1608			
R0666	nsp	RM73B--101JT +1608			
R0667	nsp	RM73B--560JT +1608			
R0668	nsp	RM73B--220JT +1608			
R0669	nsp	RM73B--101JT +1608			

	Ref. No.	Part No.	Part Name	Remarks	Q'ty	New
	R0670	nsp	RM73B--101JT +1608			
	R0671	nsp	RM73B--101JT +1608			
	R0672	nsp	RM73B--223JT +1608			
	R0673	nsp	RM73B--103JT +1608			
	R0674	nsp	RM73B--103JT +1608			
	R0675	nsp	RM73B--103JT +1608			
	R0676	nsp	RM73B--103JT +1608			
	R0677	nsp	RM73B--103JT +1608			
	R0678	nsp	RM73B--221JT +1608			
	R0679	nsp	RM73B--101JT +1608			
	R0680	nsp	RM73B--105JT +1608			
	R0681	nsp	RM73B--103JT +1608			
	R0682	nsp	RM73B--103JT +1608			
	R0683	nsp	RM73B--103JT +1608			
	R0684	nsp	RM73B--103JT +1608			
	R0685	nsp	RM73B--223JT +1608			
	R0686	nsp	RM73B--103JT +1608			
	R0687	nsp	RM73B--220JT +1608			
	R0688	nsp	RM73B--103JT +1608			
	R0689	nsp	RM73B--220JT +1608			
	R0690	nsp	RM73B--0R0KT +1608			
	R0691	nsp	RM73B--0R0KT +1608			
	R0694	nsp	RM73B--750JT +1608			
	R0695	nsp	RM73B--220JT +1608			
	R0696	nsp	RM73B--103JT +1608			
	R0701	nsp	RM73B--103JT +1608			
	R0702	nsp	RM73B--103JT +1608			
	R0703	nsp	RM73B--103JT +1608			
	R0704	nsp	RM73B--220JT +1608			
	R0705	nsp	RM73B--220JT +1608			
	R0801	nsp	MOS1CVTPA101J			
	R0802	nsp	RM73B--103JT +1608			
	R0803	nsp	RM73B--332JT +1608			
	R0811	nsp	RM73B--220JT +1608			
	R0821	nsp	RM73B--220JT +1608			
	R0831	nsp	JUMPER (L=5)			
	R0832	nsp	RM73B--472JT (1608) +1608			
	R0833	nsp	RM73B--473JT +1608			
	R0834	nsp	RM73B--103JT +1608			
	R0835	nsp	RM73B--103JT +1608			
	R0836	nsp	RM73B--103JT +1608			
⚠	R0837	nsp	RF25CVTEA100J			
	R0841	nsp	RM73B--470JT +1608			
	R0842	nsp	RM73B--470JT +1608			
	R0843	nsp	RM73B--0R0KT +1608			
	R0844	nsp	RM73B--0R0KT +1608			
	R0881	nsp	RM73B--822JT +1608			
	R0882	nsp	RM73B--223JT +1608			
	R0883	nsp	RM73B--333JT +1608			
	R0884	nsp	RM73B--563JT +1608			
	R0885	nsp	RM73B--153JT +1608			
	R0886	nsp	RM73B--822JT +1608			



	Ref. No.	Part No.	Part Name	Remarks	Q'ty	New
	C0205	nsp	C1608X7R1H104K (0.1UF 50V)			
	C0206	nsp	C1608X7R1H104K (0.1UF 50V)			
	C0207	nsp	C1608X7R1H104K (0.1UF 50V)			
	C0208	nsp	C1608X7R1H104K (0.1UF 50V)			
	C0209	nsp	C1608X7R1H104K (0.1UF 50V)			
	C0210	00MOA107025Z1	ROS-25V 101M - H4#PE - T2 (100UF 25V)			
	C0211	nsp	C1608X7R1H104K (0.1UF 50V)			
	C0212	00MOA107025Z1	ROS-25V 101M - H4#PE - T2 (100UF 25V)			
	C0213	nsp	C1608X7R1H104K (0.1UF 50V)			
	C0214	nsp	C1608X7R1H104K (0.1UF 50V)			
	C0215	nsp	C1608X7R1H104K (0.1UF 50V)			
	C0217	nsp	C1608X7R1H104K (0.1UF 50V)			
	C0218	nsp	C1608X7R1H104K (0.1UF 50V)			
	C0219	nsp	C1608X7R1H104K (0.1UF 50V)			
	C0221	nsp	C1608X7R1H104K (0.1UF 50V)			
	C0222	00MOA107025R1	ROA-25V 101M -H4#PE - T2 (100UF 25V)			
	C0223	00MOA107025R1	ROA-25V 101M -H4#PE - T2 (100UF 25V)			
	C0224	00MOA106025R1	ROA-25V 100M - E3#PE - T2 (10UF 25V)			
	C0225	00MOA226025Z1	ROS-25V 220M - F3#PE - T2 (22UF 25V)			
	C0226	00MOA226025R1	ROA-25V 220M - F3#PE - T2 (22UF 25V)			
	C0251	nsp	C1608X7R1H104K (0.1UF 50V)			
	C0252	nsp	C1608X7R1H104K (0.1UF 50V)			
	C0301	133050125408S	CQ93E2A561JT(FNS)			
	C0302	133050125408S	CQ93E2A561JT(FNS)			
	C0305	133050125415S	CQ93E2A821JT(FNS)			
	C0306	133050125415S	CQ93E2A821JT(FNS)			
	C0307	133050125415S	CQ93E2A821JT(FNS)			
	C0308	133050125415S	CQ93E2A821JT(FNS)			
	C0313	133050079420S	CQ93G2D181J(FAS)			
	C0314	133050079420S	CQ93G2D181J(FAS)			
	C0315	133050079420S	CQ93G2D181J(FAS)			
	C0316	133050079420S	CQ93G2D181J(FAS)			
	C0321	00MOF55221591	220PF 200V +- 5% FAS			
	C0322	00MOF55221591	220PF 200V +- 5% FAS			
	C0323	133050078489S	CQ93P2D470K(FAS)			
	C0324	133050078489S	CQ93P2D470K(FAS)			
	C0325	00MOA227025R1	ROA-25V 221M -H5#PE - T2 (220UF 25V)			
	C0326	00MOA227025R1	ROA-25V 221M -H5#PE - T2 (220UF 25V)			
	C0327	00MOA227016Z1	ROS-16V 221M - H5#PE - T2 (220UF 16V)			
	C0328	00MOA227016Z1	ROS-16V 221M - H5#PE - T2 (220UF 16V)			
	C0329	00MOA227025R1	ROA-25V 221M -H5#PE - T2 (220UF 25V)			
	C0330	00MOA227025R1	ROA-25V 221M -H5#PE - T2 (220UF 25V)			
	C0331	00MOA227016Z1	ROS-16V 221M - H5#PE - T2 (220UF 16V)			
	C0332	00MOA227016Z1	ROS-16V 221M - H5#PE - T2 (220UF 16V)			
	C0401	00MOA476025Z1	ROS-25V 470M - G3#PE - T2 (47UF 25V)			
	C0402	00MOA476025Z1	ROS-25V 470M - G3#PE - T2 (47UF 25V)			
	C0403	nsp	C1608X7R1H104K (0.1UF 50V)			
	C0404	nsp	C1608X7R1H104K (0.1UF 50V)			
	C0405	00MOA476025Z1	ROS-25V 470M - G3#PE - T2 (47UF 25V)			
	C0406	00MOA476025Z1	ROS-25V 470M - G3#PE - T2 (47UF 25V)			
	C0407	00MOA227025R1	ROA-25V 221M -H5#PE - T2 (220UF 25V)			
	C0408	00MOA227025R1	ROA-25V 221M -H5#PE - T2 (220UF 25V)			



Ref. No.	Part No.	Part Name	Remarks	Q'ty	New
C0451	00D2544586978	CE04W2A010MT(RA3)			
C0452	00D2544814019	CE04W1E102MC(KMG)			
C0453	00D2544586936	CE04W2A4R7MT(RA3)			
C0501	00D2570503967	CC73CH1H150JT +1608			
C0502	00D2570503967	CC73CH1H150JT +1608			
C0503	00MDK96104300	C1608X7R1H104K (0.1UF 50V)			
C0504	00D2544569911	CE04W1E470MT(RA3)			
C0505	nsp	C1608X7R1H104K (0.1UF 50V)			
C0506	nsp	C1608X7R1H104K (0.1UF 50V)			
C0507	00D2544569911	CE04W1E470MT(RA3)			
C0508	00D2544569911	CE04W1E470MT(RA3)			
C0509	nsp	C1608X7R1H104K (0.1UF 50V)			
C0510	nsp	C1608X7R1H104K (0.1UF 50V)			
C0511	nsp	C1608X7R1H104K (0.1UF 50V)			
C0512	nsp	C1608X7R1H104K (0.1UF 50V)			
C0513	00D2544569911	CE04W1E470MT(RA3)			
C0514	00D2544569911	CE04W1E470MT(RA3)			
C0516	nsp	C1608X7R1H104K (0.1UF 50V)			
C0518	nsp	CC73CH1H8R0DT +1608			
C0519	nsp	CC73CH1H8R0DT +1608			
C0520	nsp	C1608X7R1H104K (0.1UF 50V)			
C0521	nsp	C1608X7R1H104K (0.1UF 50V)			
C0522	nsp	C1608X7R1H104K (0.1UF 50V)			
C0523	00D2544569911	CE04W1E470MT(RA3)			
C0524	nsp	C1608X7R1H104K (0.1UF 50V)			
C0525	00D2544569911	CE04W1E470MT(RA3)			
C0526	nsp	C1608X7R1H104K (0.1UF 50V)			
C0527	00D2544802908	CE04W1J101MT(RA3)			
C0529	nsp	C1608X7R1H104K (0.1UF 50V)			
C0601	nsp	C1608X7R1H104K (0.1UF 50V)			
C0602	00MOA107025Z1	ROS-25V 101M - H4#PE - T2 (100UF 25V)			
C0631	nsp	C1608X7R1H104K (0.1UF 50V)			
C0632	00D2544569911	CE04W1E470MT(RA3)			
C0633	nsp	C1608X7R1H104K (0.1UF 50V)			
C0634	nsp	C1608X7R1H104K (0.1UF 50V)			
C0635	nsp	CC73CH1H6R0DT +1608			
C0636	00D2544569911	CE04W1E470MT(RA3)			
C0637	nsp	C1608X7R1H104K (0.1UF 50V)			
C0638	00D2544569911	CE04W1E470MT(RA3)			
C0639	nsp	CC73CH1H6R0DT +1608			
C0641	nsp	C1608X7R1H104K (0.1UF 50V)			
C0642	00D2544569911	CE04W1E470MT(RA3)			
C0643	00D2544569911	CE04W1E470MT(RA3)			
C0645	nsp	C1608X7R1H104K (0.1UF 50V)			
C0647	nsp	C1608X7R1H104K (0.1UF 50V)			
C0649	nsp	C1608X7R1H104K (0.1UF 50V)			
C0650	nsp	CK73B1H102KT +1608			
C0651	00D2544577945	CE04W1C101MT(RA3)			
C0652	00D2570518907	CK73B1E683KT(1608) +1608			
C0653	nsp	C1608X7R1H104K (0.1UF 50V)			
C0654	nsp	CK73B1H102KT +1608			
C0655	00D2544569911	CE04W1E470MT(RA3)			

	Ref. No.	Part No.	Part Name	Remarks	Q'ty	New
	C0656	nsp	C1608X7R1H104K (0.1UF 50V)			
	C0657	nsp	C1608X7R1H104K (0.1UF 50V)			
	C0658	nsp	C1608X7R1H104K (0.1UF 50V)			
	C0659	nsp	C1608X7R1H104K (0.1UF 50V)			
	C0660	nsp	C1608X7R1H104K (0.1UF 50V)			
	C0661	00D2544569911	CE04W1E470MT(RA3)			
	C0662	00D2544569911	CE04W1E470MT(RA3)			
	C0663	nsp	C1608X7R1H104K (0.1UF 50V)			
	C0666	00D2570503912	CC73CH1H9R0DT +1608			
	C0667	00D2570503912	CC73CH1H9R0DT +1608			
	C0669	nsp	C1608X7R1H104K (0.1UF 50V)			
	C0670	nsp	C1608X7R1H104K (0.1UF 50V)			
	C0672	nsp	C1608X7R1H104K (0.1UF 50V)			
	C0673	00D2544569911	CE04W1E470MT(RA3)			
	C0674	nsp	C1608X7R1H104K (0.1UF 50V)			
	C0675	nsp	C1608X7R1H104K (0.1UF 50V)			
	C0676	nsp	C1608X7R1H104K (0.1UF 50V)			
	C0677	nsp	C1608X7R1H104K (0.1UF 50V)			
	C0680	nsp	CC73CH1H470JT +1608			
	C0681	nsp	C1608X7R1H104K (0.1UF 50V)			
	C0682	nsp	C1608X7R1H104K (0.1UF 50V)			
	C0683	132310102500S	CK73R1H103KT (1608)			
	C0684	132310102500S	CK73R1H103KT (1608)			
	C0685	nsp	C1608X7R1H104K (0.1UF 50V)			
	C0686	00D2544586978	CE04W2A010MT(RA3)			
	C0687	nsp	C1608X7R1H104K (0.1UF 50V)			
⚠	C0803	133750061200S	#PHE840MA5100MA01R05			
	C0804	00D2544814019	CE04W1E102MC(KMG)			
	C0805	nsp	C1608X7R1H104K (0.1UF 50V)			
	C0806	nsp	C1608X7R1H104K (0.1UF 50V)			
	C0807	nsp	C1608X7R1H104K (0.1UF 50V)			
⚠	C0811	00D2544670703	CE04W1E472MC (KMQ)			
⚠	C0812	00D2544806700	CE04W1C222MC K25(KY)			
	C0813	00D2544802908	CE04W1J101MT(RA3)			
⚠	C0821	00D2544670703	CE04W1E472MC (KMQ)			
⚠	C0822	00D2544670703	CE04W1E472MC (KMQ)			
	C0823	00D2544814019	CE04W1E102MC(KMG)			
	C0824	00D2544814019	CE04W1E102MC(KMG)			
	C0825	00D2544577958	CE04W1C221MT(RA3)			
⚠	C0831	00D2544802908	CE04W1J101MT(RA3)			
⚠	C0832	00D2544802911	CE04W1J100MT(RA3)			
	C0834	00D2544802908	CE04W1J101MT(RA3)			
⚠	C0853	00MOB33802570	3300U 25V(ALP) (LF)-BLOCK CAP			
⚠	C0854	00MOB33802570	3300U 25V(ALP) (LF)-BLOCK CAP			
	C0855	00MOA106025R1	ROA-25V 100M - E3#PE - T2 (10UF 25V)			
	C0856	00MOA106025R1	ROA-25V 100M - E3#PE - T2 (10UF 25V)			
	C0857	00MOA477016Z6	ROS-16V 471M - I6#PE - S13 (470UF 16V)			
	C0858	00MOA477016Z6	ROS-16V 471M - I6#PE - S13 (470UF 16V)			
	C0882	nsp	CK73B1E223KT +1608			
	C0883	nsp	CK73B1E223KT +1608			
	C0884	00D2544806700	CE04W1C222MC K25(KY)			
	C0885	nsp	C1608X7R1H104K (0.1UF 50V)			

Ref. No.	Part No.	Part Name	Remarks	Q'ty	New
C0886	nsp	CK73B1H102KT +1608			
C0887	00D2544802908	CE04W1J101MT(RA3)			
C0888	nsp	C1608X7R1H104K (0.1UF 50V)			
C0889	nsp	C1608X7R1H104K (0.1UF 50V)			
C0890	00D2544577945	CE04W1C101MT(RA3)			
C0891	00D2544586978	CE04W2A010MT(RA3)			
C0892	nsp	C1608X7R1H104K (0.1UF 50V)			
C0893	00D2544577945	CE04W1C101MT(RA3)			
C0901	133050074586S	CQ93M2E471J(LP)			
C0902	nsp	C1608X7R1H104K (0.1UF 50V)			
C0903	nsp	C1608X7R1H104K (0.1UF 50V)			
C0921	nsp	C1608X7R1H104K (0.1UF 50V)			
C0922	00MOA107025Z1	ROS-25V 101M - H4#PE - T2 (100UF 25V)			
C0923	nsp	C1608X7R1H104K (0.1UF 50V)			
C0924	nsp	CC73CH1H330JT +1608			
C0926	nsp	C1608X7R1H104K (0.1UF 50V)			
C0927	nsp	CK73B1H222KT +1608			
C0928	nsp	C1608X7R1H104K (0.1UF 50V)			
C0930	nsp	C1608X7R1H104K (0.1UF 50V)			
C0931	nsp	C1608X7R1H104K (0.1UF 50V)			
C0932	nsp	RUBBER SHEET			
C0932	00MDD38104011	50V DC 0.1UF +80 -20%			
C0941	nsp	C1608X7R1H104K (0.1UF 50V)			
<b>OTHERS PARTS GROUP</b>					
△	F0801	00MFS20125201	# T1.25A 250V VDE SWMKO		
△	F0802	00MFS20125201	# T1.25A 250V VDE SWMKO		
△	F0803	00MFS20125201	# T1.25A 250V VDE SWMKO		
△	F0804	00MFS20315201	# FUSE 3.15A 250V SEMKO VDE		
△	F0851	00MFS20080201	# FUSE 0.8A 250V SEMKO VDE		
△	F0852	00MFS20080201	# FUSE 0.8A 250V SEMKO VDE		
	L0101	nsp	RM73B--220JT +1608		
	L0102	nsp	RM73B--220JT +1608		
	L0103	nsp	RM73B--0R0KT +1608		
	L0104	nsp	RM73B--0R0KT +1608		
	L0105	nsp	RM73B--0R0KT +1608		
	L0106	nsp	RM73B--0R0KT +1608		
	L0107	nsp	RM73B--220JT +1608		
	L0108	nsp	RM73B--0R0KT +1608		
	L0109	nsp	RM73B--0R0KT +1608		
	L0110	nsp	RM73B--0R0KT +1608		
	L0111	nsp	RM73B--0R0KT +1608		
	L0112	nsp	RM73B--0R0KT +1608		
	L0113	nsp	RM73B--0R0KT +1608		
	L0114	nsp	RM73B--0R0KT +1608		
	L0115	nsp	RM73B--0R0KT +1608		
	L0116	nsp	RM73B--0R0KT +1608		
	L0117	nsp	RM73B--0R0KT +1608		
	L0118	nsp	RM73B--0R0KT +1608		
	L0202	nsp	E.FIL(BLM21PG221SN1)+2125		

	Ref. No.	Part No.	Part Name	Remarks	Q'ty	New
	L0203	nsp	E.FIL(BLM21PG221SN1)+2125			
	L0251	nsp	E.FIL(BLM21PG221SN1)+2125			
	L0451	nsp	E.FIL(BLM21PG221SN1)+2125			
	L0501	nsp	E.FIL(BLM21PG221SN1)+2125			
	L0502	nsp	E.FIL(BLM21PG221SN1)+2125			
	L0601	nsp	E.FIL(BLM21PG221SN1)+2125			
	L0602	nsp	E.FIL(BLM21PG221SN1)+2125			
	L0632	nsp	E.FIL(BLM21PG221SN1)+2125			
	L0633	nsp	E.FIL(BLM21PG221SN1)+2125			
	L0811	nsp	E.FIL(BLM21PG221SN1)+2125			
	L0821	nsp	E.FIL(BLM21PG221SN1)+2125			
	L0822	nsp	E.FIL(BLM21PG221SN1)+2125			
	L0823	nsp	E.FIL(BLM21PG221SN1)+2125			
	L0831	nsp	E.FIL(BLM21PG221SN1)+2125			
	L0841	nsp	E.FIL(BLM21PG221SN1)+2125			
	L0842	nsp	E.FIL(BLM21PG221SN1)+2125			
	L0921	nsp	E.FIL(BLM21PG221SN1)+2125			
	L0922	nsp	E.FIL(BLM21PG221SN1)+2125			
	L0923	00D2318063009	PULSE TRANS			
	L0941	nsp	E.FIL(BLM21PG221SN1)+2125			
	N0101	nsp	17P FFC BASE(9610SC)			
	N0103	nsp	29P FFC.BASE(9610SCA +REF			
	N0104	nsp	20P FFC BASE(9610SC)			
	N0181	nsp	B6B-PH-K-S (LF)(SN)			
	N0182	nsp	B5B-PH-K-S (LF)(SN)			
	N0201	nsp	B6B-PH-K-S (LF)(SN)			
	N0202	nsp	17P FFC BASE(9610SC)			
	N0203	nsp	17P FFC BASE(9610SC)			
	N0205	nsp	7P FFC BASE(9610SC)			
	N0251	nsp	B6B-PH-K-S (LF)(SN)			
	N0301	nsp	B2B-EH			
	N0302	nsp	B2B-EH			
	N0401	nsp	B8B-PH-K-S (LF)(SN)			
	N0501	nsp	6P FFC BASE(9610SC)			
	N0502	nsp	B3B-PH-K-S (LF)(SN)			
	N0601	nsp	25P FFC.BASE(9610SCA +REF			
	N0631	nsp	25P FFC BASE (9610SD +REF			
	N0801	nsp	CONNECTOR 2P B3P-VH			
	N0802	nsp	CONNECTOR 2P B3P-VH			
	N0803	nsp	B7B-EH			
	N0851	nsp	B3B-EH 3P			
	N0941	nsp	7P FFC BASE (9610SD)			
△	S0801	00D2140242001	RELAY(DLS9D1-O_M)			
	S0901	00MSS02021620	SSSU121700			
	K0631	262010004005S	TORX147L(25M,F,T,J)			
	K0632	00D2051295105	USB(B)CON. FLANGE			
	K0633	643010074603S	1P RCA_PIN_JACK			
	K0901	00MYT02020890	YKC21-3046V 2P RCA PIN JACK			
	K0921	263010017004S	TOTX147L(25M,F,T,J)			

Ref. No.	Part No.	Part Name	Remarks	Q'ty	New
K0922	643010074603S	1P RCA_PIN_JACK			
B0201	nsp	GND TERMINAL FOR PCB			
B0251	nsp	GND TERMINAL FOR PCB			
B0301	nsp	M3 SCREW TERMINAL			
B0302	nsp	M3 SCREW TERMINAL			
B0401	nsp	GND TERMINAL FOR PCB			
B0631	nsp	M3 SCREW TERMINAL			
B0632	nsp	M3 SCREW TERMINAL			
B0801	nsp	GND TERMINAL FOR PCB			
B0802	nsp	GND TERMINAL FOR PCB			
B0941	nsp	M3 SCREW TERMINAL			
X0101	00MFQ02005070	CSTCE20M0V53-R0			
X0502	00D3991127905	FCX-03(48MHZ)			
X0503	141810009501S	FCX-03(16.9344MHZ)			
X0631	00D3991038900	FCX-03(12MHZ)			
X0632	00D3991053901	FCX-03(24.576MHZ)			
⚠ T0881	00D2336614003	POWER TRANS(MINI/E3)	U		
⚠ T0881	00D2336615002	POWER TRANS(MINI/E2)	K,N		
Z0103	nsp	STYLE PIN			
Z0181	nsp	STYLE PIN			
Z0501	nsp	NANOSMDC110F			
Z0808	nsp	STYLE PIN			
Z0811	nsp	HEAT SINK			
Z0812	nsp	SHIELD			
Z0813	nsp	SCREW			
Z0821	nsp	HEAT SINK			
Z0822	nsp	SHIELD			
Z0823	nsp	SCREW			
Z0831	nsp	HDAM CASE(CUPPERHDAM			
Z0835	nsp	UL TUBE (L=15,D6.6)			
Z0851	nsp	SHIELD			
Z0852	nsp	SHIELD			
Z0853	nsp	HEAT SINK			
Z0854	nsp	HEAT SINK			
Z0855	nsp	SCREW			
Z0856	nsp	SCREW			
Z0857	nsp	STYLE PIN			
	nsp	RUBBER SHEET			